OPERATING INSTRUCTIONS FOR

MODEL 2750

Turbine Generator Gas Analyzer



P/N M76700

4/09/2012



DANGER



Toxic gases and or flammable liquids may be present in this monitoring system.
Personal protective equipment may be required when servicing this instrument.
Hazardous voltages exist on certain components internally which may persist for a time even after the power is turned off and disconnected.
Only authorized personnel should conduct maintenance and/or servicing.
Before conducting any maintenance or servicing, consult with authorized supervisor/manager.

Copyright © 2012 Teledyne Analytical Instruments

All Rights Reserved. No part of this manual may be reproduced, transmitted, transcribed, stored in a retrieval system, or translated into any other language or computer language in whole or in part, in any form or by any means, whether it be electronic, mechanical, magnetic, optical, manual, or otherwise, without the prior written consent of Teledyne Analytical Instruments, 16830 Chestnut Street, City of Industry, CA 91749-1580.

Warranty

This equipment is sold subject to the mutual agreement that it is warranted by us free from defects of material and of construction, and that our liability shall be limited to replacing or repairing at our factory (without charge, except for transportation), or at customer plant at our option, any material or construction in which defects become apparent within one year from the date of shipment, except in cases where quotations or acknowledgements provide for a shorter period. Components manufactured by others bear the warranty of their manufacturer. This warranty does not cover defects caused by wear, accident, misuse, neglect or repairs other than those performed by Teledyne or an authorized service center. We assume no liability for direct or indirect damages of any kind and the purchaser by the acceptance of the equipment will assume all liability for any damage which may result from its use or misuse.

We reserve the right to employ any suitable material in the manufacture of our apparatus, and to make any alterations in the dimensions, shape or weight of any parts, in so far as such alterations do not adversely affect our warranty.

Important Notice

This instrument provides measurement readings to its user, and serves as a tool by which valuable data can be gathered. The information provided by the instrument may assist the user in eliminating potential hazards caused by his process; however, it is essential that all personnel involved in the use of the instrument or its interface, with the process being measured, be properly trained in the process itself, as well as all instrumentation related to it.

The safety of personnel is ultimately the responsibility of those who control process conditions. While this instrument may be able to provide early warning of imminent danger, it has no control over process conditions, and it can be misused. In particular, any alarm or control systems installed must be tested and understood, both as to how they operate and as to how they can be defeated. Any safeguards required such as locks, labels, or redundancy, must be provided by the user or specifically requested of Teledyne at the time the order is placed.

Therefore, the purchaser must be aware of the hazardous process conditions. The purchaser is responsible for the training of personnel, for providing hazard warning methods and instrumentation per the appropriate standards, and for ensuring that hazard warning devices and instrumentation are maintained and operated properly.

Teledyne Analytical Instruments, the manufacturer of this instrument, cannot accept responsibility for conditions beyond its knowledge and control. No statement expressed or implied by this document or any information disseminated by the manufacturer or its agents, is to be construed as a warranty of adequate safety control under the user's process conditions.

Turbine Generator Gas Analyzer

Specific Model Information

The instrument for which this manual was supplied may incorporate one or more options not supplied in the standard instrument. Commonly available options are listed below, with check boxes. Any that are incorporated in the instrument for which this manual is supplied are indicated by a check mark in the box.

Instrument Serial Number: _____

Options Included in the Instrument with the Above Serial Number:

Safety Messages

Your safety and the safety of others is very important. We have provided many important safety messages in this manual. Please read these messages carefully.

A safety message alerts you to potential hazards that could hurt you or others. Each safety message is associated with a safety alert symbol. These symbols are found in the manual and inside the instrument. The definition of these symbols is described below:

GENERAL WARNING/CAUTION: Refer to the instructions for details on the specific danger. These cautions warn of specific procedures which if not followed could cause bodily injury and/or damage the instrument.



CAUTION: Hot Surface Warning: This warning is specific to heated components within the instrument. Failure to heed the warning could result in serious burns to skin and underlying tissue.



WARNING: Electrical Shock Hazard: Dangerous voltages appear within this instrument. This warning is specific to an electrical hazard existing at or nearby the component or procedure under discussion. Failure to heed this warning could result in injury and/or death from electrocution.



Technician Symbol: All operations marked with this symbol are to be performed by qualified maintenance personnel only.



NOTE: Additional information and comments regarding a specific component or procedure are highlighted in the form of a note.

No Symbol

CAUTION: **THE ANALYZER SHOULD ONLY BE USED FOR THE PURPOSE AND IN THE MANNER DESCRIBED IN THIS MANUAL.**



Turbine Generator Gas Analyzer

IF YOU USE THE ANALYZER IN A MANNER OTHER THAN THAT FOR WHICH IT WAS INTENDED, UNPREDICTABLE BEHAVIOR COULD RESULT POSSIBLY ACCOMPANIED WITH HAZARDOUS CONSEQUENCES.

This manual provides information designed to guide you through the installation, calibration and operation of your new analyzer. Please read this manual and keep it available.

Occasionally, some instruments are customized for a particular application or features and/or options added per customer requests. Please check the front of this manual for any additional information in the form of an Addendum which discusses specific information, procedures, cautions and warnings that may be peculiar to your instrument.

Manuals do get lost. Additional manuals can be obtained from Teledyne at the address given in the Appendix. Some of our manuals are available in electronic form via the Internet. Please visit our website at: www.teledyne-ai.com.

Table of Contents

Safety Messages	iv
Table of Contents	vi
List of Figures.....	viii
List of Tables	ix
Introduction	11
1.1 Overview	11
1.2 Analysis Ranges	11
1.3 Enclosure	12
1.4 Connections	13
1.5 Operator Interface	14
Theory of Operation	15
2.1 Thermal Conductivity	15
2.2 Electronics	17
Installation	19
3.1 Electrical Connections	19
3.2 Gas Connections	20
3.2.1 Vent Line	21
3.2.2 Pressure Regulation	21
3.3 Calibration	22
3.3.1 Zero Calibration Procedure	23
3.3.2 Span Calibration Procedure	26
Setup and Operation	31
4.1 Setup	31
4.2 Operation	32

Turbine Generator Gas Analyzer

Maintenance.....	35
5.1 Routine Maintenance	35
5.1.1 Instrument Cleaning	35
5.1.2 Periodic Calibration	35
5.1.3 Leak Checking	35
5.2 Troubleshooting	36
Appendix.....	39
A.1 Specifications	39
A.2 Spare Parts List	40

List of Figures

Figure 1-1: Front View of the Model 2750	12
Figure 1-2: Gas Connections.....	13
Figure 1-3: Electrical Connections.....	13
Figure 1-4: Interface Panel	14
Figure 3-1: Electronics Block Diagram	17
Figure 3-1: Electrical Connections.....	20
Figure 3-2: Gas Connections.....	21
Figure 3-3: Interface Panel Showing Calibration Switch Position ..	23
Figure 3-4: Interface Panel Showing Calibration Switch Position ..	24
Figure 3-5: H2/CO2 Trim Pot.....	24
Figure 3-6: Cal Switch in H2/AIR Position	25
Figure 3-7: H2/AIR Zero Trimpot	25
Figure 3-8: Range Switch in AIR/CO2 Position	27
Figure 3-9: AIR/CO2 Span Trimpot	27
Figure 3-10: Range Switch in H2/CO2 Position.....	28
Figure 3-11: H2/CO2 Span Trimpot.....	28
Figure 3-12: Range Switch in H2/AIR Position	28
Figure 3-13: H2/AIR Span Trimpot	29
Figure 4-1: Power and Output Connections to the Model 2750.....	32

Turbine Generator Gas Analyzer

List of Tables

Table 2-1: Thermal Conductivity for Selected Gases	15
Table 4-1: Troubleshooting.....	36

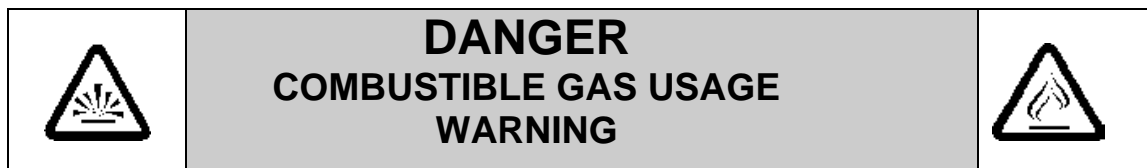

This is a general purpose instrument designed for use in a non-hazardous area. It is the customer's responsibility to ensure safety especially when combustible gases are being analyzed. The potential for gas leaks always exist.

The operator of this equipment should fully understand the principles of operation for this instrument. Misuse of this product in any manner, tampering with its components, or unauthorized substitution of any component may adversely affect the safety of this instrument.

Since the use of this instrument is beyond the control of Teledyne, no responsibility by Teledyne, its affiliates, and agents for damage or injury from misuse or neglect of this equipment is implied or assumed.

WARNING: USING NON-COMBUSTIBLE GASES CAN EXPOSE THE USER TO THE RISK OF ASPHYXIATION. ALWAYS USE CAUTION WHEN WORKING WITH ANY GAS IN CONTAINED AREAS; MAKE SURE THERE IS PROPER VENTILATION AVAILABLE IN THE WORK AREA. TAI RECOMMENDS THE USE OF SAFETY MONITORS TO ENHANCE USER SAFETY.



WARNING: THERE ARE NO USER SERVICEABLE PARTS CONTAINED IN THIS ANALYZER. FOR SERVICE OR REPAIR, CONTACT TELEDYNE ANALYTICAL INSTRUMENTS FOR QUALIFIED SERVICE PERSONNEL OR AN RMA NUMBER.



Introduction

1.1 Overview

The Model 2750 Turbine Generator Gas analyzer is a portable microcontroller based three-channel analyzer designed to measure the concentration of a single gas component in a binary mixture of gases. A special thermal conductivity cell responds to the difference in thermal conductivity between the components of a gas mixture and produces a signal output which is linearized over the specific range of interest. Each channel is separately linearized for enhanced accuracy. The cell is maintained at a fixed temperature to minimize any thermally induced error.

This analyzer is specifically designed for use during the maintenance of turbine generators. The three ranges allow the user to monitor the turbine's blanketing gas as the turbine is in use or during maintenance. It provides a range of 80%- 100% hydrogen in a background (impurity) of air for hydrogen purity monitoring. Two ranges, 0-100% hydrogen in a background of CO₂, and 0-100% air in a background of CO₂ are used to monitor the blanketing gas during the purge cycles. During normal operation the turbine is blanketed with 100% hydrogen. For maintenance the hydrogen is first purged from the enclosure with CO₂ for fire safety. This process is followed by an air purge for worker safety. This process is reversed prior to bringing the turbine back into service.

1.2 Analysis Ranges

The Model 2750 has 3 separate user selectable analysis ranges controlled by a 3-position rotary switch.

Standard analysis ranges include:

- 0-100% hydrogen in CO₂
- 0-100% air in CO₂
- 80-100% hydrogen in air

The thermal conductivity sensor senses the thermal conductivity (T/C) or heat transfer rate of the sampled gas mixture and produces an electrical signal proportional to its heat conductivity. The T/C of the two gases in the mixture are significantly different. Because of this difference, the T/C of the gas mixture will be proportional to the percentage of each gas in the mixture. The resulting raw signal from the sensor is linearized and ultimately converted into a concentration readout on the digital display. Although it is possible to obtain a digital readout using almost any binary mixture of gases with a reasonable thermal conductivity difference, this instrument is designed and internally calibrated for only those gases and analysis ranges listed above. Any other mixture will produce erroneous results. Contact the factory if your application requires an analysis range not listed above.

1.3 Enclosure

The Model 2750 is a portable instrument housed in a rugged impact resistant NEMA 4X polyethylene enclosure which can easily be set up at the point of analysis and field-calibrated. The top of the case opens to reveal the operator interface panel. The analysis section is located in the cover section of the enclosure. See Figure 1-1.



Figure 1-1: Front View of the Model 2750

1.4 Connections

Gas connections are made on the top cover of the enclosure using the 1/8 tube inlet and 3/16" barb sample return fittings supplied. Power is supplied from a 9V DC adapter powered from a universal 90 – 264 VAC 47-63 Hz power source. The adapter plugs into a port on the side of the main panel. Figure 1-2 shows the gas connections and Figure 1-3 shows the electrical connections.

A 0-1 VDC (0.8-1VDC on the H₂/Air range) output signal is available to the user via a 2-pin connector located on the side of the unit. This signal is linear across the selected range and can be used to trigger alarms, record output or remote logging and data display.

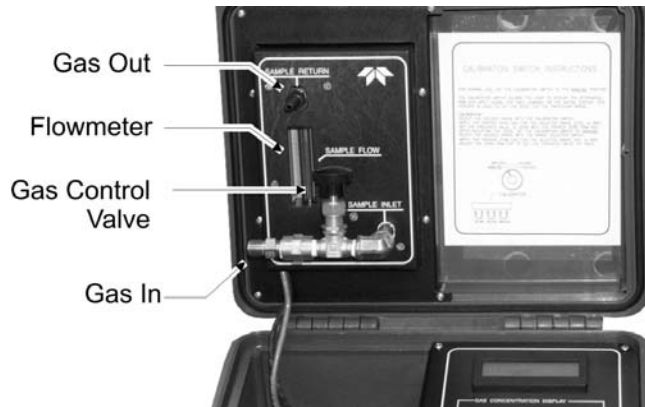

Figure 1-2: Gas Connections



Figure 1-3: Electrical Connections

1.5 Operator Interface

The front panel contains the operator interface and is readily accessible after opening the enclosure. It is simple, consisting of an OFF/ON switch and two rotary switches—one for selecting between analysis or calibration modes and the other for selecting the particular analysis range to be employed during measurement. On the same panel are trim pots used in calibrating the unit.

A large 3.5 digit digital display shows the gas concentration or calibration information depending on the analyzer mode. A flowmeter located in the analyzer's cover monitors the gas flow through the instrument.

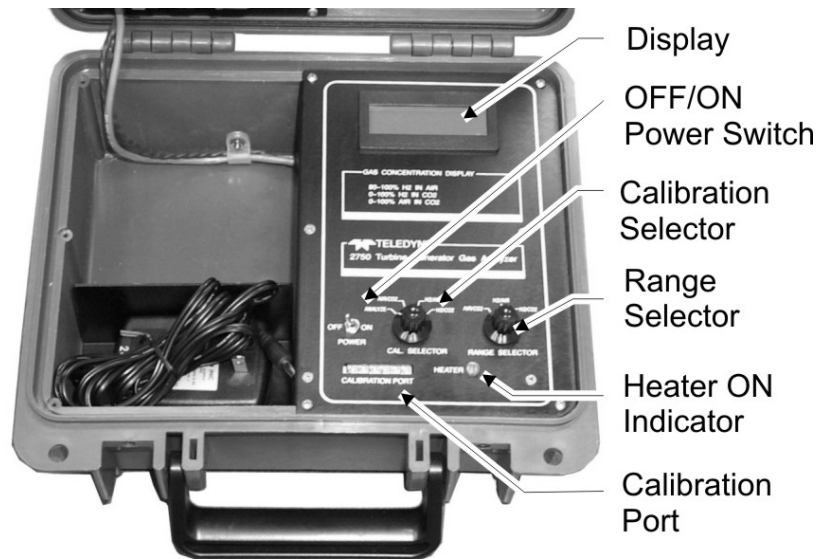

Figure 1-4: Interface Panel

Theory of Operation

The heart of the Model 2750 Turbine Generator Gas Analyzer is the compact thermal conductivity cell. It senses differences in thermal conductivity of the gas mixture and generates an output signal based on the thermal characteristics of the gas. Since the sensor measures the absolute T/C using an internal thermal reference, a reference gas is not required.

2.1 Thermal Conductivity

Thermal conductivity is a measure of a substance's ability to conduct heat. It also varies with temperature and is further complicated by the fact that this variation is not always linear. As an illustration, Table 2-1 lists the thermal conductivity for selected gases at 2 different temperatures. It also lists the percentage difference in thermal conductivity (T/C) for the specified temperature range.

Table 2-1: Thermal Conductivity for Selected Gases

Gas	Thermal Conductivity (cal/sec)/(cm ² C/cm) x 10 ⁻⁶		% Difference
	26.7°C	48.9°C	
CO ₂	39.67	43.81	10.44%
CO	59.92	63.89	6.63%
N ₂	62.4	65.71	5.30%
Air	62.2	66.04	6.17%
O ₂	63.64	68.19	7.15%
He	360.36	376.07	4.36%
H ₂	446.32	471.11	5.55%

As seen in table 2-1, CO₂ has over 10% change in its thermal conductivity over the stated temperature range. This would result in unacceptable accuracy if the temperature of the gas were not controlled during analysis. Simply compensating for the temperature change is not sufficient unless the temperature fluctuation is extremely small.

When measuring the thermal conductivity in a mixture of gases, best performance is realized when there is a large T/C difference between the gases. For example, it is relatively straightforward to determine the concentration of hydrogen in air at 26.7°C based on T/C measurements since the relative difference in thermal conductivities is great—446.32 (H₂) and 62.2 (air). However it becomes difficult or impossible to distinguish nitrogen (64.4) in air (62.2) at the same temperature using only the difference in thermal conductivities, as they are so close to each other.

Thermal conductivity analyzers are not gas specific, they monitor the change in the thermal conductivity of a gas mixture. The sensor itself has no way of knowing whether the mixture is hydrogen in air or hydrogen in CO₂, it only knows what the thermal conductivity of the gas mixture is. A reading of 60% would be meaningless unless the components of the gas are known, the analysis range is known, and the instrument is properly calibrated for that mixture on that range.

The Model 2750 Turbine Generator Gas Analyzer is designed for analyzing the following binary gas mixtures and ranges:

- 0-100% hydrogen in CO₂
- 0-100% air in CO₂
- 80-100% hydrogen in air

This instrument should not be used for any other gas mixtures or ranges different from above unless you have thoroughly examined the gas mixture in question and have determined that it is equivalent to one of the installed ranges. This instrument uses pre-programmed data for linearization purposes which, in general, would not apply to another mixture.

CAUTION: **MEASURING HYDROGEN IN AIR BETWEEN THE RANGES OF 4% TO 74.2% HYDROGEN IS COMBUSTIBLE AND SHOULD BE AVOIDED FOR SAFETY REASONS.**



2.2 Electronics

The Model 2750 uses a sophisticated miniature solid-state thermal conductivity sensor. This cell uses internal temperature compensation circuitry. It has both a reference and a measurement leg. The reference leg is driven by a constant current source and is used to heat the sensor's substrate and to thermally compensate for ambient fluctuations. The sensor membrane then operates at a constant temperature around 70°C.

Refer to Figure 3-1 for the block diagram of the electronics used in the Model 2750.

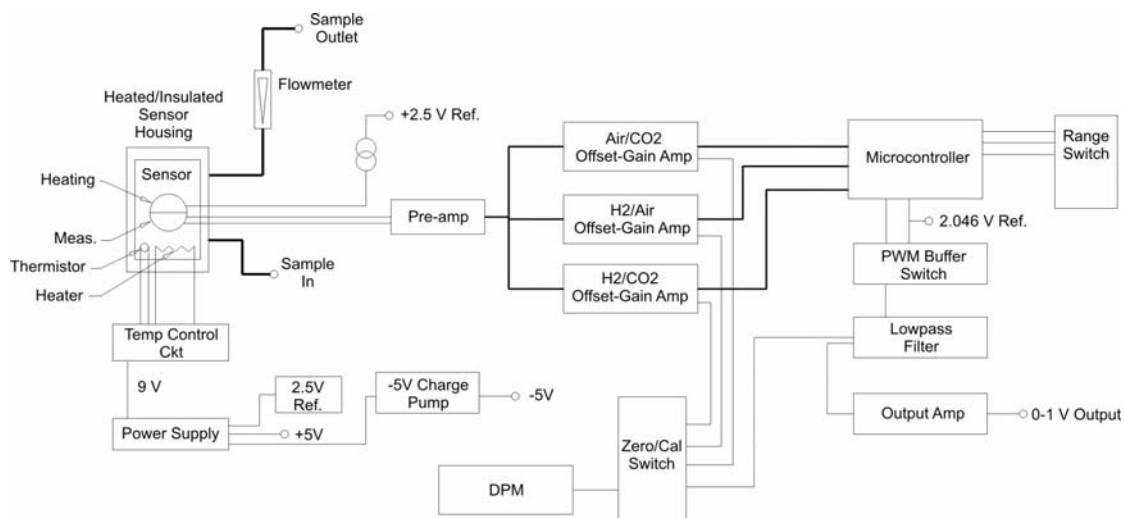

Figure 3-1: Electronics Block Diagram

Current generated in the measuring leg of the sensor is sent to a buffer amplifier. The output voltage from the amplifier then goes to 3 individual zero offset gain amplifiers, one for each analysis range. Each offset amplifier has its own span attenuator. Both the zero offset amplifiers and the span attenuators are used in setting the zero and span for each range. The three outputs from the offset amplifiers are delivered to the PIC microcontroller where the signals are digitized and then linearized. The linearization process uses separate linearization tables for each instrument range. Each table includes a 10 point correction curve which was pre-programmed in at the factory to provide linearity across the specific range. The output from the microcontroller is a pulse

width modulated (PWM) signal that is proportional to the gas concentration on that specific range.

The PWM signal is passed through a low pass filter and is used to drive the display and the 0-1 VDC output signal (0.8 – 1VDC for the H₂/Air range).

The calibration switch is a rotary switch and allows either the percent of range signal or the output from the zero offset gain amplifiers to be sent to the display.

Installation

The Model 2750 is a portable unit and can easily be setup close to the analysis site. To ensure accuracy, however, the analyzer should be setup in such a manner as to avoid:

- Direct sunlight
- Drafts of air
- Shock and vibration
- Temperatures below 30° F or above 110° F

For best results, the analyzer should be placed as close as possible to the sample point to minimize the effects of sample line lag time on the analysis.

An outline diagram, showing the location and identification of the gas port and electrical connections, as well as the physical dimensions of the analyzer case, is included in the drawings at the rear of the manual.

Installation is quick and easy and consists of:

- Power and signal output connection
- Connecting the sample or calibration gas
- Allowing the analyzer to warm up.
- Calibrating the instrument.

3.1 Electrical Connections

Power to the instrument is supplied by a 90-264 VAC 47-63 Hz universal external power adapter. This adapter provides 1.4 Amperes at 9 VDC required by the instrument. The adapter plugs into a port on the left side of the main panel as shown in Figure 3-1.

A second port, also on the left side of the panel, provides access to a 0-1 VDC (0.8 – 1 VDC for the H₂ in Air range) output signal for percent of range monitoring or recording. A connector is supplied for interfacing to this port. To use this signal, connect a 2-conductor

shielded cable (nominally No. 22 wire size) between the analyzer output connector and the recording equipment. See Figure 3-1.

Note: The signal output connector must be removed before closing the analyzer cover.

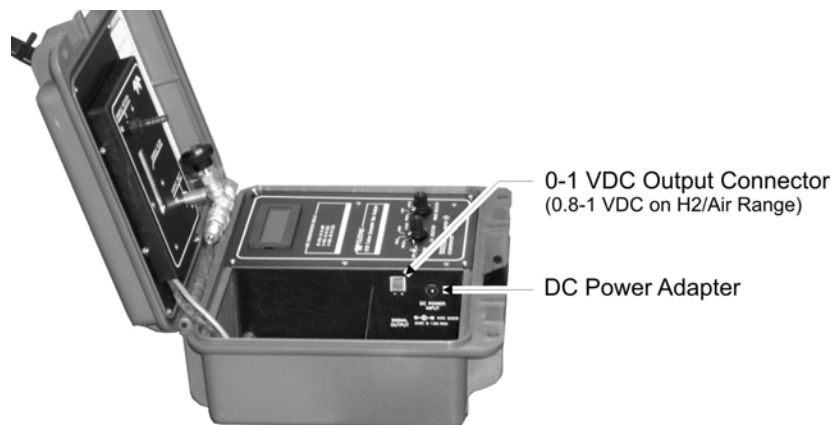

Figure 3-1: Electrical Connections

3.2 Gas Connections

Inlet gas connections are made at the gas control valve mounted on the upper panel. Connect the sample or calibration gas to the gas control valve using the 1/8" tube connector on the gas control valve. See Figure 3-2.

Note: To limit sensor contamination it is recommended that you install an inline sample filter in the sample in line.

CAUTION: HYDROGEN IS A HIGHLY FLAMMABLE GAS. UTMOST CARE IS REQUIRED IN MAKING LEAK-TIGHT CONNECTIONS TO THE INSTRUMENT. DO NOT OVER TIGHTEN THE INLET GAS FITTING. USE A COMMERCIAL SOAP SOLUTION OR OTHER LEAK DETECTION METHOD TO ENSURE THAT ALL GAS CONNECTIONS ARE LEAK-FREE.



Connect a sample return line to the 3/16" barbed hose connection which is located above the flowmeter as shown in Figure 3-2. Make sure

there are no kinks or obstructions in the return line to avoid over pressurizing and possibly damaging the analyzer.

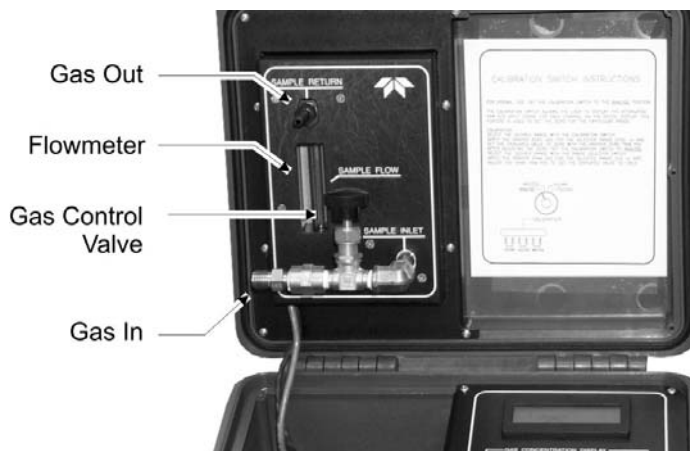

Figure 3-2: Gas Connections

3.2.1 Vent Line

Gases exiting the instrument should be vented to an area remote from the analyzer. **This line must not be blocked!** The following precautions must be observed in vent line installation:

1. Use 3/16" ID tubing to eliminate any backpressure or restricted flow.
2. Vent to an area where the ambient pressure is normal atmospheric pressure.
3. The ambient pressure in the vent area must undergo no more than normal barometric pressure changes.
4. The vent line must be installed in such a manner as to avoid water and dirt accumulation.

3.2.2 Pressure Regulation

All incoming gas lines from a high-pressure source should be equipped with pressure regulators. Pressure regulators should be installed as close to the sample take off point as possible to minimize sample line lag time.

Note: Always use two stage regulators on incoming gas lines from high-pressure sources.

Sample pressure should be set between 0.5—30 psi, typically 5 psig at the analyzer. **CAUTION: HIGH FLOW RATES CAN DAMAGE THE SENSOR.**

3.3 Calibration

The Model 2750 has been calibrated at the factory but will require periodic recalibration (zero and span).

The calibration gases used to calibrate the instrument are:

Zero: 100% CO₂ for 0-100% H₂ in CO₂ and 0-100% Air in CO₂ ranges

100% Air for 80-100% H₂ in Air range

Span: 100% air for 0-100% Air in CO₂ range.

100% H₂ for both the 0-100% H₂ in CO₂ and 80-100% H₂ in Air ranges

For the best accuracy, the analyzer should be calibrated with the same gases that will be used to service the generator. This should compensate for most small impurities that may be present in the service gases

To calibrate the analyzer, both zero and span values must be set or verified for each range. Always use the calibration switch position to verify the zero setting on each range. This is required because the microcontroller cannot see negative offsets. Use the procedures in Sections 3.3.1 and 3.3.2 for calibrating the Model 2750.

- Gas to be analyzed or being used for calibration needs to be pressure regulated to approximately 5 psig and the flow kept below 1 SFCH or the cell could be damaged
- If the Trim Pots are adjusted too far past 100%, the reading will return to 0%. If this happens, turn the trim pot back until the reading drops below 100% and then make the final setting.

Note: Perform a zero calibration before span calibration.

3.3.1 Zero Calibration Procedure

1. Connect the zero gas (100% CO₂) to the sample valve. Make sure that the pressure regulator is set at approximately 5 psig.

CAUTION:

ALWAYS HAVE THE SAMPLE FLOW VALVE CLOSED WHEN TURNING ON THE SAMPLE (OR CALIBRATION GAS) STREAM. FLOW RATES GREATER THAN 2.5 SCFH CAN DAMAGE THE SENSOR.

2. If not already connected, connect the vent line.
3. Plug the DC adapter into the unit. See Figure 3-2. Plug the other end into a 90-264 VAC 43-67 Hz supply.
4. Turn the instrument on and allow it to warm up for 20 minutes.
5. Allow the zero gas to flow through the analyzer. Wait several minutes before making any flow adjustments. Then set the gas flow to 0.5-1 SCFH using the flow control valve.
6. With CO₂ flowing through the instrument, set the calibration switch (see Figure 3-3) to the air/CO₂ position for zeroing that range. Verify that the range selector switch is on the air/CO₂ position.

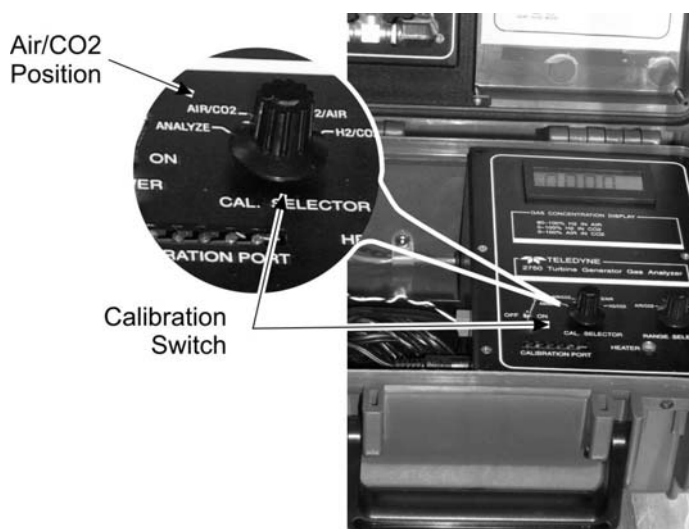

Figure 3-3: Interface Panel Showing Calibration Switch Position

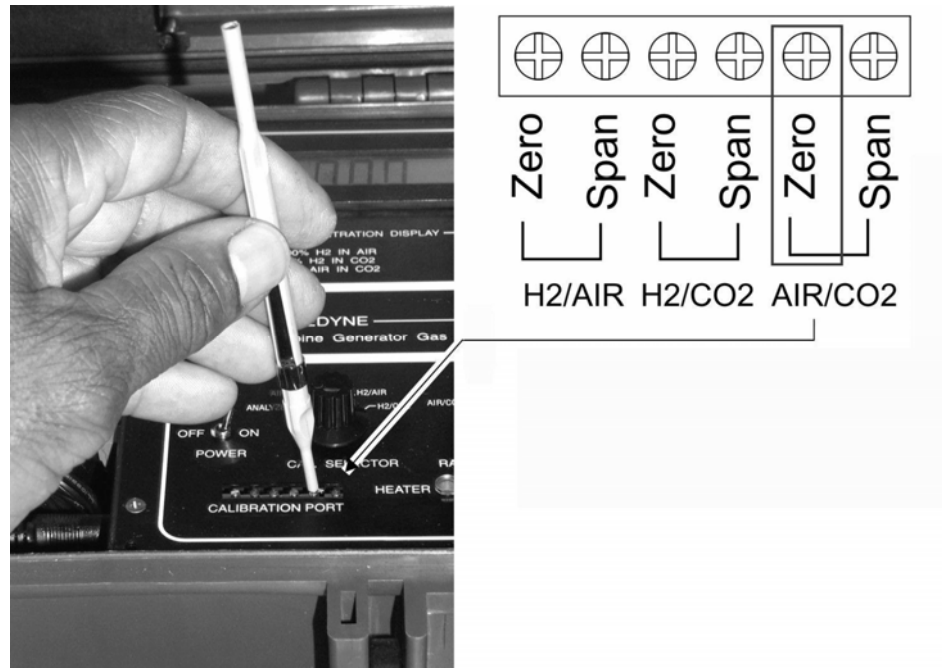

Figure 3-4: Interface Panel Showing Calibration Switch Position

7. Use the air/CO₂ zero trim pot to adjust the display to zero. See Figure 3-4 above.
8. Move the calibration switch to the H₂/CO₂ position and verify that the range selector switch is on H₂/CO₂. Use the H₂/CO₂ zero trim pot to adjust the display to zero. See Figure 3-5

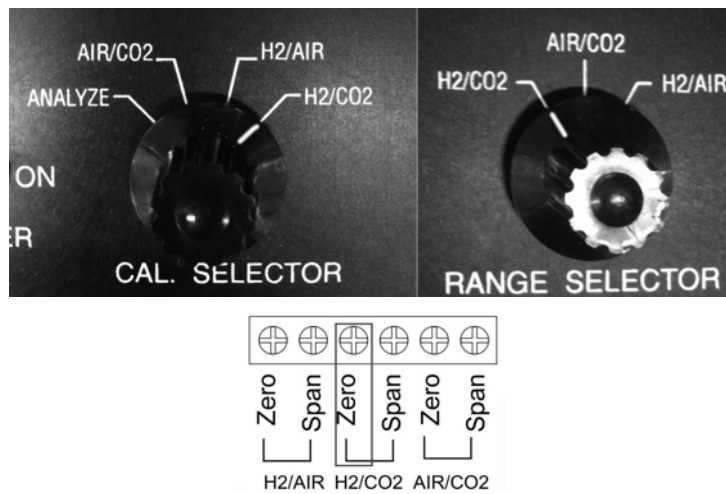

Figure 3-5: H₂/CO₂ Trim Pot

- After successfully zeroing with CO₂ on the two ranges (air/CO₂ and H₂/CO₂) close the sample valve and disconnect the CO₂ source. Replace with 100% air source. Make sure that the pressure regulator is set at approximately 5 psig.

CAUTION: ALWAYS HAVE THE SAMPLE FLOW VALVE CLOSED WHEN TURNING ON THE SAMPLE (OR CALIBRATION) GAS SOURCE. FLOW RATES GREATER THAN 2.5 SCFH CAN DAMAGE THE SENSOR.



- Allow the air to flow through the analyzer. Wait several minutes before making any flow adjustments. Then set the gas flow to 0.5-1 SCFH using the flow control valve.
- Set the calibration switch to the H₂/air position and verify the range selector is on H₂/air. See Figure 3-6

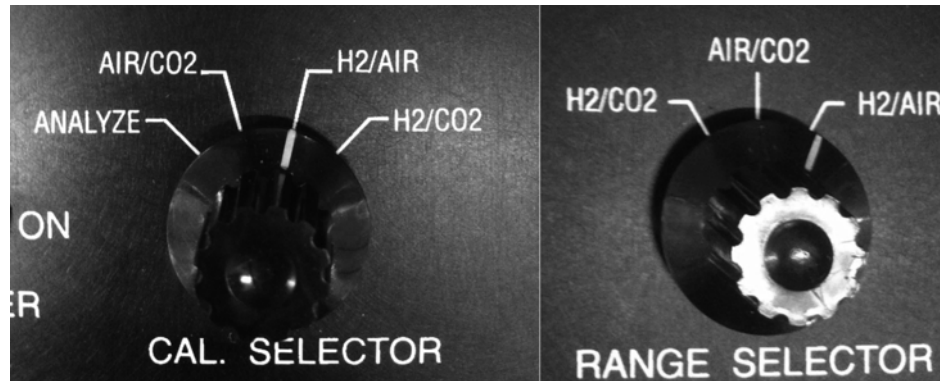

Figure 3-6: Cal Switch in H₂/AIR Position

- Use the H₂/air zero trim pot to zero that range by adjusting the pot until the display reads zero. See Figure 3-7

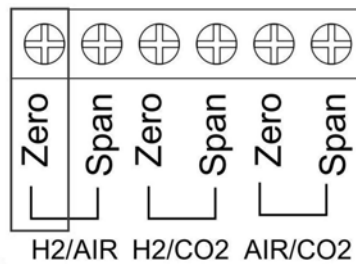



Figure 3-7: H₂/AIR Zero Trimpot

Please note that the 80-100% H₂ in Air range is actually a 0-20% H₂ in Air range with the 2750 doing the simple calculation to report the reading as hydrogen purity. Thus the zero adjustment uses 100% air.

The zero calibration is now complete, continue with a span calibration.

3.3.2 Span Calibration Procedure

Note: A zero calibration must be performed before a span calibration.

CAUTION:  **ADJUST THE SPAN POT SLOWLY AS THE READING APPROACHES 100%. IF THE SPAN READING EXCEEDS 104-105%, THE READING WILL SUDDENLY DROP BACK TO ZERO. IF THIS HAPPENS SLOWLY TURN THE SPAN POT IN THE OPPOSITE DIRECTION UNTIL THE READING COMES BACK TO 100+ AND SET TO 100%**

1. If not immediately following a zero calibration, verify the zero of the instrument using the procedures in Section 3.3.1.
2. Connect the 100% air to the instrument. Make sure the regulator is set at approximately 5 psig.

CAUTION:  **ALWAYS HAVE THE SAMPLE FLOW VALVE CLOSED WHEN TURNING ON THE SAMPLE (OR CALIBRATION) GAS SOURCE. FLOW RATES GREATER THAN 2.5 SCFH CAN DAMAGE THE SENSOR.**

3. Open the sample valve to flow the span gas. Wait a few minutes then adjust the flow to 0.5-1 SCFH.
4. Set the calibration switch to ANALYZE and set the range switch to air/CO₂ position. See Figure 3-8.



Figure 3-8: Range Switch in AIR/CO2 Position

- Adjust the air/CO₂ span trim pot so that the display indicates 100% \pm 0.1%. See Figure 3-9

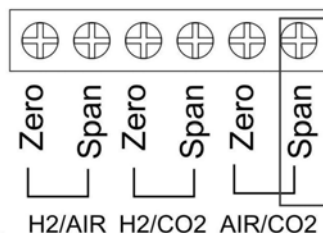

Figure 3-9: AIR/CO₂ Span Trimpot

- After successfully completing the span calibration on the air/CO₂ range, close the sample valve and replace the air span gas source with the H₂ span gas source. Make sure the regulator is set at approximately 5 psig.

CAUTION: HYDROGEN IS A FLAMMABLE AND EXPLOSIVE GAS. ALWAYS USE CARE WHEN HANDLING HYDROGEN GAS. MAKE SURE THERE ARE NO LEAKS IN THE SAMPLE IN OR VENT LINES AND THAT THE VENT LINE IS DIRECTED IN A SAFE MANNER.



- Allow H₂ to flow for a few minutes to fully purge the instrument. Set the flow between .5-1 SCFH.
- Make sure the calibration switch is in the ANALYZE position then set the range switch to the H₂/CO₂ position. See Figure 3-10

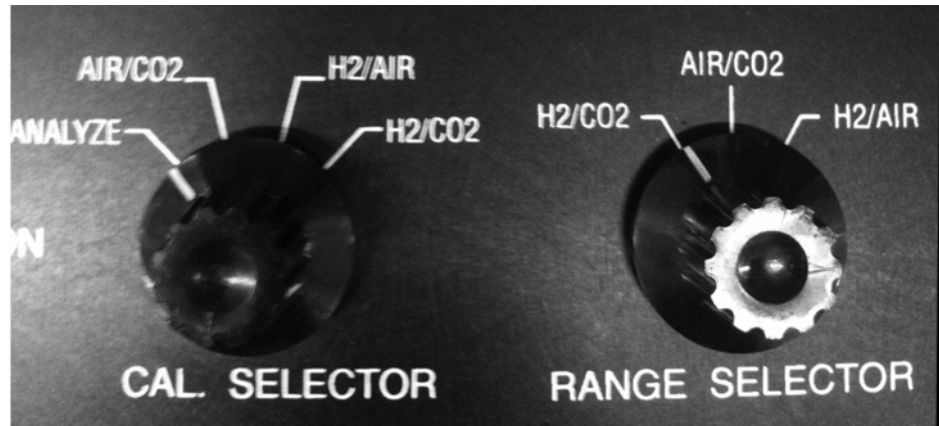

Figure 3-10: Range Switch in H2/CO2 Position

- Use the H₂/CO₂ span trim pot to adjust the display to 100% ±0.1%. See Figure 3-11

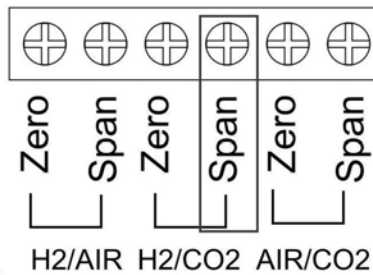

Figure 3-11: H₂/CO₂ Span Trimpot

- Select The H₂/Air range with the range selector switch. See Figure 3-12



Figure 3-12: Range Switch in H₂/AIR Position

11. Adjust the display to read 100% $\pm 0.1\%$ using the H2/Air span trimpot. See Figure 3-13

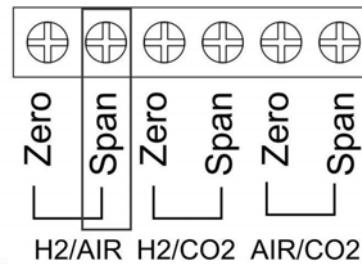

Figure 3-13: H2/AIR Span Trimpot

Please note that while the operating range of the analyzer is 80-100% H₂ in Air, the electronics of the 2750 have been configured to allow for the use of 100% H₂ span gas to calibrate this range to reduce the number of calibration gases that are required.

The analyzer is now fully calibrated and ready for service.

Setup and Operation

4.1 Setup

Setup consists of:

- Calibrating the instrument
- Attaching the sample and vent lines
- Leak checking
- Attaching power cable
- Attaching output cable
- Turning the instrument on and allowing it to warm up

Prior to using the Model 2750, it must be calibrated on all three ranges. Refer to Section 3.3 for calibration procedures.

Once the instrument is calibrated, it may be transported to the analysis site.

Note: It is sometimes more convenient to calibrate the instrument at the analysis site.

Open the cover and attach the sample line to the sample valve using the 1/8" tubing connector. Attach a suitable vent line heeding the precautions stated in Section 3.2.1. Leak check thoroughly all connections and tubing using a commercially available soap solution for this task.

CAUTION:  **HYDROGEN IS A FLAMMABLE AND EXPLOSIVE GAS. NEVER LEAVE ANYTHING TO CHANCE WHEN USING HYDROGEN. ALWAYS LEAK CHECK THE SYSTEM PRIOR TO USE.**

Plug the 9V DC adapter into the power port and the other end to a 90-264 VAC power outlet. Plug in the 0-1 VDC output cable into the output port if you intend to record the data from the analyzer. See Figure 4-1.



Figure 4-1: Power and Output Connections to the Model 2750

The thermal conductivity sensor relies on a precise heat load to produce an accurate thermally compensated output signal. The sensor must be allowed to heat up and equilibrate before using the instrument for analysis. Generally, warm up time takes about 15-20 minutes before the heater lamp begins to cycle indicating it is at the operation temperature.

The instrument is now ready to be used for analysis.

4.2 Operation

1. After configuring the instrument according to the procedures specified in the previous section, engage the sample stream at the regulator.

Note: Always have the sample flow control valve on the instrument closed when engaging the sample stream. This will avoid any high velocity sample transients accidentally directed through the analyzer that could possibly damage the sensor. Flow rates above 2.5 SCFH can damage the sensor.

2. Adjust the pressure regulator to 0.5-30 psig.
3. Slowly open the sample valve and adjust the flow on the flowmeter to 0.1-1 SCFH.

Note: The operator must know in advance what gas mixture is present in the sample stream to be able to properly select the instrument range. All ranges will give some indication of output (even if zero) but only that range corresponding to the correct sample gas mixture will give an accurate reading.

4. Make sure the calibration switch is in the analyze position
5. Select the proper range and allow gas to flow for several minutes to purge the lines of any residual air or gas.

Note: Whenever switching gases, always allow a sufficient purge time to remove the residual gas. Note the changing concentration values until a steady reading is obtained (unless the sample gas stream concentration is changing). When the reading settles, the instrument is sufficiently purged.

6. Read the sample gas concentration from the display.

Maintenance

5.1 Routine Maintenance

The Model 2750 Turbine Generator Gas Analyzer is a rugged instrument and needs little maintenance. Routine maintenance is limited to instrument cleaning, periodic calibration and leak checking. If any part of the instrument malfunctions or fails to perform, the unit should be removed from service and returned for repair and calibration. The 2750 contains no user-serviceable parts.

5.1.1 Instrument Cleaning

Use a damp cloth to wipe the instrument clean. Do not use abrasive cleansers or solvents especially on the LCD. Do not store the instrument with the case open and in direct sunlight.

5.1.2 Periodic Calibration

The Model 2750 will require periodic calibration; the frequency will depend on the user's application and frequency of use. It is a good idea to verify the zero each time the unit is used. If the zero has drifted then perform both a zero and span calibration on all ranges. Refer to Section 3.3 for calibration procedures.

5.1.3 Leak Checking

CAUTION: HYDROGEN IS A FLAMMABLE AND EXPLOSIVE GAS. NEVER USE A FLAME TO CHECK FOR LEAKS.



CAUTION: DO NOT PERFORM LEAK CHECKING OR ANALYSIS IN AN AREA WHERE EXPOSED FLAMES OR IGNITION SOURCES ARE PRESENT



CAUTION: WHEN USING HYDROGEN GAS OR HYDROGEN GAS MIXTURES, MAKE SURE THE GAS EXITING THE UNIT IS VENTED PROPERLY.



If a leak detector is available, the model can be leak checked with the power off. Use helium and pressurize the lines to 1-5 psig and sniff all fittings and lines.

If a leak detector is not available, admit air at 1-5 psig through the instrument lines. Liberally apply a commercial soap bubble solution to all fittings and lines. Most leaks occur at the gas inlet fitting.

CAUTION: DO NOT USE THIS INSTRUMENT UNTIL IT SUCCESSFULLY PASSES A LEAK CHECK TEST.



5.2 Troubleshooting

Table 5-1 describes common problems and corrective action to be taken.

Table 4-1: Troubleshooting

Symptom	Corrective Action
Unit does not turn ON when actuating Power	(a) Check DC adapter is mated in securely to the port connector. or (b) Check DC Adapter is plugged into 90-264VAC 47-63 Hz power. or (c) Power adapter is defective—replace adapter.
Heater lamp does not illuminate or illuminates continuously	(a) No power to the unit—see above. or (b) Unit cannot attain proper temperature due to wind or temperature too cold—move unit out of wind/draft or to a warmer area.
Display reads negative (with zero gas flowing through)	(a) ZERO control may be misadjusted. Perform a zero

<p>analyzer) in the calibration mode.</p>	<p>check and recalibrate if necessary.</p> <p>or</p> <p>(b) Improper zero source. Check source.</p> <p>or</p> <p>(c) Improper range selected—select proper range for zero.</p>
<p>No sample flow</p>	<p>(a) Sample flow valve closed—open the valve.</p> <p>or</p> <p>(b) Pressure at regulator set too low—reset the regulator to 0.5-30 psig</p> <p>or</p> <p>(c) No sample gas connected—connect sample gas.</p> <p>or</p> <p>(d) Vent or sample in line is blocked. Remove constriction or blockage.</p>
<p>Analyzer does not respond to sample gas</p>	<p>(a) Incorrect instrument range selected. Select proper range for analysis.</p> <p>or</p> <p>(b) Make sure CAL switch is in Analyze mode.</p> <p>or</p> <p>(c) No sample flow—check flowmeter.</p>

Appendix

A.1 Specifications

- Range:** 0-100% hydrogen in CO₂
0-100% air in CO₂
80-100% hydrogen in air
- Accuracy:** $\pm 5\%$ at constant temp & pres (equilibrium)
 $\pm 6\%$ at constant pressure over operating
temp range
- Sensor:** Thermal conductivity cell
- Resolution:** 0.1%
- Response Time:** 0-90% in less than 10 seconds (0.5 SCFH
flowrate)
- Drift Rate:** <1%/day
- Display:** 3 1/2" LCD
- Flowrate:** 0.5-1 SCFH nominal
2.5 SCFH maximum
(0.5-30 psig)
- Wetted Parts:** Brass, SS, aluminum, glass, Teflon, nylon
- AC Power:** 9V DC power adapter powered from
a 90-264 47-63 Hz VAC (US type 2 prong
plug)
- Enclosure:** NEMA 4X PET plastic housing
- Dimensions:** (10.6 L x 4.8 H x 9.9 W)in
(269.2 x 121.9 x 251.5) mm
- Operating Temp:** 0-40°C
- Voltage output:** 0-1VDC (0.8-1 VDC 80-100% range)

A.2 Spare Parts List

QTY	PART NO	DESCRIPTION
1	A692	9 VDC POWER Adapter 90-264 VAC 47-63Hz
1	P1244	Trim Pot Tool

A minimum charge is applicable to spare parts orders.

Note: Orders for replacement parts should include the part number (if available) and the model and serial number of the instrument for which the parts are intended.

Orders should be sent to:

TELEDYNE Analytical Instruments

16830 Chestnut Street
City of Industry, CA 91748

Phone (626) 934-1500, Fax (626) 961-2538

Web: www.teledyne-ai.com

or your local representative.