

# INSTRUCTION MANUAL

## 311XL SERIES

### 0-2 PPM Full Scale Trace Oxygen Analyzer

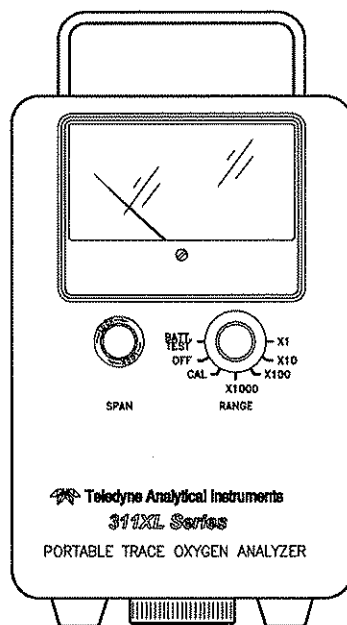

#### **DANGER**

HIGHLY TOXIC AND OR FLAMMABLE LIQUIDS OR GASES MAY BE PRESENT IN THIS MONITORING SYSTEM.

PERSONAL PROTECTIVE EQUIPMENT MAY BE REQUIRED WHEN SERVICING THIS SYSTEM. HAZARDOUS VOLTAGES EXIST ON CERTAIN COMPONENTS INTERNALLY WHICH MAY PERSIST FOR A TIME EVEN AFTER THE POWER IS TURNED OFF AND DISCONNECTED.

ONLY AUTHORIZED PERSONNEL SHOULD CONDUCT MAINTENANCE AND/OR SERVICING. BEFORE CONDUCTING ANY MAINTENANCE OR SERVICING CONSULT WITH AUTHORIZED SUPERVISOR/MANAGER.

P/N M70255  
10/28/09  
ECO # 09-0172



Additional information for your **Portable Oxygen Analyzer**.

C.O.:

The instruction manual included with your analysis system from Teledyne Analytical Instruments (TAI) describes the standard features of the system. It is as accurate as possible in describing the standard theory, operation, maintenance and calibration. Refer to the manual for information regarding all standard features of the model that you have selected.

**NOTE:** *All drawings that relate to your instrument are included in the drawing package at the rear of this manual.*

## Standard Options

The following options are available for the Model 311XL Series Trace Oxygen Analyzers. Depending on the options that you selected at the time of purchase, these features may or may not be included as part of your instrument. A "√" in a box indicates that your instrument has that feature and the adjacent description and instructions apply.

## Model Selected

- Model 311XL Portable Trace Oxygen Analyzer
- Model 311TCXL Trace Oxygen Analyzer

## CE Conformity

This TAI Model 311TCXL Series Oxygen Analyzers meet or exceed all requirements of the Commonwealth of Europe (CE) for Radio Frequency Interference and Electromagnetic Interference (RFI/EMI) protection.

## Battery Recharging (Power Requirements)

This instrument operates from rechargeable batteries. The battery recharging circuit requires the power source checked below.

100VAC-115VAC @ 50/60Hz

*NOTE: The standard battery charging time of 24 hours is based on a minimum voltage of 110VAC. With 100VAC as the recharging voltage, you must increase the battery recharging schedule to 28 hours every four weeks of continuous use (instead of 24 hours).*

220VAC @ 50/60Hz

Other: \_\_\_\_\_

## Analysis Ranges

If this box is checked, your instrument has nonstandard analysis ranges and those ranges are listed below:

Range 1: \_\_\_\_\_

Range 2: \_\_\_\_\_

Range 3: \_\_\_\_\_

Range 4: \_\_\_\_\_

## Cell Block (P/N B25589)

This instrument has a stainless steel cell block installed in place of the standard block.

## Cell Block Fittings (P/N S615)

The quick disconnect fittings of the cell block are constructed of stainless steel.

## Micro-Fuel Cell (P/N C-6689-B2CXL)

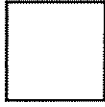

**B-2CXL Micro-Fuel Cell is a standard Sensor**

### ***Micro-Fuel Cell Upgrade/Replacement***

A class B-2CXL micro-fuel cell (MFC) has been included. This MFC is used for monitoring trace levels of O<sub>2</sub> in CO<sub>2</sub>-free gas streams.

## **ADDENDUM – ANALYZER MODEL 311XL SERIES**

The following delineates a complete list of operating faults:

### **Failure to Calibrate**

- Verify sensor is installed in unit
- Verify span gas concentration
- Verify Sensor is within warranty period
- Install another sensor
- Verify that the batteries installed are fully charged by setting the unit to the “Test Battery” mode as indicated on the front panel

### **Batteries Failing to Charge**

- Verify connection of AC Power. Charge unit only in a safe area.
- If batteries are several years old, they may need to be replaced.

### **Inaccurate Analysis Results**

- Check unit calibration
- Check adequacy of sample gas flow into the instrument
- Check for leaks in the sample delivery system.

### **Precautionary Statements**

- This apparatus is not intended to be exposed to dust conditions.
- This unit has been designed such that it does:
  - ✓ Not give rise to physical injury or other harm due to contact
  - ✓ Not produce excessive surface temperatures or infra red energy, electromagnetic radiation or ionizing radiation.
  - ✓ Not have non-electrical dangers.
- The unit should not be installed where it may be subjected to mechanical and thermal stresses or where it may be attacked by existing or foreseeable aggressive substances.
- This unit cannot be repaired. It must be replaced by an equivalent unit in the event of unit failure.

## WARNING

The sensor(s) used in this instrument uses electrolytes which contain substances that are extremely harmful if touched, swallowed, or inhaled. Avoid contact with ANY fluid or powder in or around the unit. What may appear to be plain water could contain one of these toxic substances.

- SKIN CONTACT: Flush contact area with cold water for several minutes. Seek medical attention.
- EYE CONTACT: Flush with cold water for at least 15 minutes. Seek immediate medical attention.
- IF SWALLOWED: Drink milk or milk of magnesia. Seek immediate medical attention.
- IF INHALED: Move immediately to an area of fresh air, or assist victim to fresh air. If victim is having difficulty breathing, use artificial respiration or administer oxygen. Seek immediate medical attention.

## TABLE OF CONTENTS

### 311XL SERIES

|       |  |    |
|-------|--|----|
| 1.    | INTRODUCTION   | 1  |
| 1.1   | Description  | 1  |
| 1.2   | Method of Analysis                                       | 1  |
| 1.3   | Outstanding Features                                     | 1  |
| 1.3.1 | Micro-Fuel Cell  | 1  |
| 1.3.2 | Reliable Calibration                                     | 2  |
| 1.3.3 | Integral Power Supply                                    | 2  |
| 1.3.4 | Accuracy and Response                                    | 3  |
| 1.3.5 | Compact Packaging  | 3  |
| 2.    | SUPPORTING EQUIPMENT AND SERVICES                        | 4  |
| 2.1   | Sampling Equipment                                       | 4  |
| 2.2   | Power Service  | 4  |
| 3.    | OPERATION  | 5  |
| 3.1   | Introduction   | 5  |
| 3.2   | Calibration  | 6  |
| 3.2.1 | Standard (Span) Calibration Procedure                    | 6  |
| 3.3   | Positive Pressure Sampling                               | 6  |
| 3.4   | Atmospheric Pressure Sampling                            | 7  |
| 4.    | MAINTENANCE  | 8  |
| 4.1   | Battery Power Supply Services                            | 8  |
| 4.2   | Routine Maintenance                                      | 8  |
| 4.3   | Cell Replacement   | 8  |
| 4.4   | Cell Warranty  | 19 |
| 5.    | TRANSDUCTION AND TEMPERATURE COMPENSATION                | 10 |
| 6.    | LEAK TESTING   | 10 |
| 7.    | SPECIFICATION DATA                                       | 12 |
|       | SPARE PARTS LIST   | 13 |
|       | DRAWING LIST   | 14 |
|       | APPENDIX - Effect of CO <sub>2</sub> on B-2CXL Cell Life | 15 |



## 311XL SERIES

### TRACE OXYGEN ANALYZER

#### 1. INTRODUCTION

**1.1 Description:** The Teledyne Analytical Instruments (TAI) Model 311XL and 311TCXL are portable, intrinsically safe trace oxygen analyzer which can be operated without an external power source. These analyzers will be referred to as Model 311XL or 311XL Series analyzers in this manual.

The instrument provides for trace oxygen analysis in decade steps ranging from 0-2 to 0-10,000 ppm (full scale) plus a special calibration range that encompasses the known oxygen concentration of atmospheric air (209,000 ppm).

Sample oxygen is read from an extremely accurate integral meter whose range of measurement is determined by the position of the range selector switch. The linear 5 inch scale (mirror equipped to eliminate parallax) provides excellent resolution and accuracy.

Sample gas is introduced and vented via a pair of quick disconnect fittings that feature integral shutoff valves which automatically close when the mating male fitting is withdrawn. The fittings are an integral part of the measuring cell manifold so that internal sample passage volume is at an absolute minimum. Sample flow control of 0.5 to 5 liters/min. must be accomplished with accessory equipment.

**1.2 Method of Analysis.** The sample oxygen is measured by a unique electrochemical transducer which functions as a fuel cell. Oxygen diffusing into the cell reacts electro-chemically to produce an electrical current that is proportional to the oxygen concentration in the gas phase immediately adjacent to the transducer's sensing surface. The linear, but minute, signal produced by the transducer from trace oxygen is amplified by a two stage amplifier. The dual stages of amplification provide enough gain to drive meter and thermistor controlled network utilized to compensate for the positive temperature co-efficient of the transducer.

**1.3 Outstanding Features.** The following unique features are incorporated into the Model 311XL:

**1.3.1 Micro-Fuel Cell:** The Micro-Fuel Cell\* is a sealed electrochemical transducer with no electrolyte to change or electrodes to clean. When the cell reaches the end of its useful life, it is merely thrown away and replaced, as one would replace a worn out battery in a flashlight.

**1.3.2 Reliable Calibration.** Although this instrument can be calibrated with air, the use of a calibration gas gives better results on the lower PPM ranges. If the instrument is exposed to high concentrations of oxygen (percent levels), it will take a significant amount of time to purge the oxygen from the sensor and analyzer for use in the low PPM level measurements (24 hours or longer).

**1.3.3 Integral Power Supply.** The differential power +/- 3.6 volts D.C.) of the instrument amplifier is furnished by two internally mounted 750 milliampere hour nickel cadmium batteries. Fully charged, these batteries will provide enough power to operate the instrument continuously for a period of about 30 days. Furthermore, an overnight charge on a three weeks duty cycle should keep the original batteries supplied usable for many years.

An integral charging circuit and a detectable power cord are provided so that the batteries may be recharged from any 50 or 60 cycle, 100 to 115 volt, convenience outlet.

The instrument is designed to either sample or have its batteries recharged. Both operations cannot be carried out simultaneously. TAI has deliberately interlocked the circuitry so that both operations cannot be carried on at the same time.

Only when the selector switch is placed in the OFF position will the neon lamp on the back plate of the Model 311XL light up to indicate power to the battery charging circuit.

\* U.S. Pat. Nos. 3,767,552 and 3,668,101

A current limiting resistor (R1 and R2) is potted into the end of each battery. This assures that under no circumstances can more than 25 milliamperes (100 milliwatts) be switched or drawn from either battery supply. This means that the Model 311XL may be used in explosive atmospheres where arcs of 100 milliwatts or less can be tolerated.

This safety feature does not apply when the instrument is being charged (AC power cord connected and selector switch in the "OFF" position). The instrument should not be used in explosive atmospheres when the batteries are being charged.

To determine the state of the rechargeable batteries turn the range selector knob counterclockwise to the battery test position and hold there (spring loaded switch). Observe that the meter indicator stays within the battery limits, \*if not, recharge of the batteries is in order). Release Range Selector Switch, it will automatically return to the OFF position.

**1.3.4 Accuracy and Response.** Accuracy at 25°C and constant pressure after thermal equilibrium has been reached. Basic accuracy: +/- 2% of full scale for all ranges except 0-2 PPM range. Accuracy for 0-2 PPM range: +/- 5% of full scale.

Accuracy over the temperature range 0-35°C at constant pressure after thermal equilibrium has been reached. Basic accuracy: +/- 5% of scale for all ranges except 0-2 PPM range. Accuracy for 0-2PPM range, +/- 10% of full scale.

If the instrument is moved from one ambient temperature to another of 10°C or higher differential, the instrument should be allowed to equilibrate for 3-4 hours before being used. The readings obtained during the transition time may be in error greater than the specifications.

Response time: 90% in 90 sec. on the 0-2 PPM range with a flow rate of 2.5 SCFH.

**1.3.5 Compact Packaging.** The instrument is housed in a 6-1/8" X 9-1/2" X 5-5/8" aluminum case that is equipped with a carrying handle and foot pads. When in use, the analyzer should be placed in an upright position on a level surface (off level positioning will detract from meter accuracy).

Access to the instrument interior is gained by loosening (ccw) the three (3) 1/4 turn screw driver type fasteners on the back of the outer case. The case may then be detached from the driver type fasteners on the back of the outer case. The case may then be detached from the control panel assembly. Further disassembly may be accomplished by removing the back plate assembly from its four (4) mounting standoffs and laying the two separated assemblies out as illustrated on the "Analyzer Wiring Diagram". The diagram is included among the drawings at the rear of the manual.

## 2. SUPPORTING EQUIPMENT AND SERVICES

**2.1 Sampling Equipment.** The customer must provide a means of controlling the pressure and flowrate of the sample gas. For positive pressure applications, TAI suggests a simple throttle valve installed in the sample line between the sample point and the analyzer. The flowrate should be limited to between 0.5 and 5 liters/min.

**IMPORTANT:** If a pressure regulator is necessary or desirable, it must have a metallic diaphragm. Regulators with organic or plastic diaphragms are permeable to oxygen and, if used in the sampling system, will lead to high oxygen readings.

For atmospheric pressure sampling, connect a pump and flow control valve downstream from the analyzer and draw (rather than push) the sample through the instrument.

TAI supplies three (3) male disconnect fittings with the instrument. One for installation of the customer's sample line; one to be used to open the vent fitting of the instrument, (equipped with a plastic tube) and one for calibration purposes.

**2.2 Power Service.** A source of single phase, 100 to 125 volt, 50 or 60 Hertz power, capable of delivering a maximum of 1/4 ampere of current will be periodically required to recharge the instrument's battery power supply. An eight (8) foot, 3-wire detach- able power cord is provided with the instrument and should be stored in a safe place when not in use. As a no cost option the 311XL can be furnished with 220 volt, 50 or 60 Hertz charging power.

### 3. OPERATION

**3.1 Introduction.** The Model 311XL is supplied completely assembled and ready for instant use. The Micro-Fuel Cell must be installed prior use. When a sensor is first installed, the instrument should be purged for 12-16 hours with zero gas (an inert gas such as nitrogen or argon with less than 0.1 ppm oxygen). This will remove any trace levels of oxygen from the sensor or the instrument. The integral shut-off valves in the quick disconnect sample fittings, if not disturbed, will maintain this inert atmosphere within the manifold indefinitely (the equilibrium concentration of oxygen is normally less than 1000 ppm).

When the range selector is advanced from the "OFF" position, power to the instrument's circuitry is established. The meter will constantly respond to the residual oxygen within the integral sample passages. It is impossible to achieve a "perfect" seal of the internal sample system, and what the meter is indicating is the diffusion -- consumption balance point of the internal sample system and the Micro-Fuel Cell. This "balance" point, with a properly calibrated instrument is always within the limits of the X100 range. If the reading climbs off the limits of this scale, a leak in the manifold assembly is indicated.

**TO EXTEND CELL LIFE AND MINIMIZE THE TIME REQUIRED TO MAKE THE NEXT ANALYSIS, THE INSTRUMENT SHOULD ALWAYS BE PURGED WITH THE SAMPLE OR AN INERT GAS PRIOR TO BEING TAKEN OUT OF SERVICE FOR STANDBY OR STORAGE.**

**3.2 Calibration.** The inherently constant output of the cell during its useful life precludes a definitive calibration cycle. TAI feels that the interval between calibrations should be dictated by the customer's application. If the instrument is being used to certify the oxygen content of a product for delivery, then, a calibration prior to certification would certainly be in order. If, on the other hand, the instrument is being used to monitor or guard a sample and the evidence provided by the analyzer will in themselves determine when a calibration check is in order. **The sensitivity of the analyzer should be checked at two to four week intervals.**

### **3.2.1 Calibration Procedure.**

Gas requirements:

Zero gas: An inert gas (nitrogen or argon) with less than 0.1 PPM oxygen concentration.

Span gas: An inert gas (nitrogen or argon) with a known trace amount of oxygen. The oxygen content should be 70 – 90% of the full scale on the range of interest (working or primary range).

Note, if this instrument is exposed to high concentrations of oxygen (percent levels), it will take a significant amount of time to purge the oxygen from the sensor and analyzer for use for low PPM level measurements. For best results, calibration should be done on the range of use. The instrument should be allowed to equilibrate to room temperature prior to calibration (a minimum of 3 hours). The instrument should be purged with zero gas prior to calibration if the instrument has been exposed to high levels of oxygen, or when the cell has been replaced or newly installed. The purge should be continued until the oxygen reading is less than 10% of scale on the range of interest (this level will not be achieved if the zero gas contains more than 0.2PPM of oxygen and operating in the 2 ppm full scale).

#### **Gas connections.**

**Note when attaching gas lines to the instrument, the vent line should always be the first attached and the last line removed. This will prevent sudden pressure changes across the sensor.** A fitting has been supplied with a short length of plastic tubing for use in the vent port to prevent backward air diffusion during calibration. Either of the two gas ports located on the rear of the analyzer can be used for the sample vent. All of the connections between the gas source and the analyzer must be of high quality (metal tubing and Swagelok type connections are recommended). Verify that there are no leaks in the gas connection lines between the instrument and the source prior to use. The gas may be regulated at 5 PSIG and flown at a rate of 1 liter/minute (control parameters are not critical).

#### **Zero adjustment.**

Place the instrument upright on a level surface and set the switch to the off position. Set the meter to zero with meter adjustment screw located immediately below the meter dial.

#### **Span adjustment.**

Purge instrument prior to calibration if required. If zero gas is not available, the span or calibration gas can be used for purging by allowing additional time for the signal level to stabilize. Attach the calibration gas to the sample inlet on the analyzer, and turn on the instrument. Select the proper range for calibration based on the calibration gas. Allow the instrument to stabilize until the reading remains steady over a period of at least 10 min.

**Note: large adjustments should not be required! Unlock and adjust the span control until the meter reading matches the calibration standard and re-lock the span dial.**

Remove the sample-in connection immediately followed by the sample-vent connection prior to turning off the calibration gas flow. This will prevent air from entering the analyzer, or the pressurizing the sensor compartment. The analyzer is now ready for use.

**3.3 Positive Pressure Sampling.** When connecting the instrument to a positive pressure sample source, ALWAYS proceed as follows:

- 1) Install the vent fitting first, and then the sample source fitting. Be prepared to make the connections in rapid order, so that atmospheric diffusion time through the vent fitting is held to a minimum.
- 2) Establish a flowrate in the sample line of from 0.2 to 5 liters/min. Allow the sample to flow long enough to allow a stable low reading to be achieved.

When disconnecting the instrument, reverse the procedure: source fitting first, and then vent fitting.

The objective of the connection -- disconnection procedure is to obviate the possibility of pressurizing the manifold. **IF A FLOWING SAMPLE WERE CONNECTED TO THE MANIFOLD WITHOUT THE VENT FITTING IN PLACE, THE PRESSURE IN THE MANIFOLD WOULD RISE AND BE EQUAL TO THE SAMPLE PRESSURE ALMOST IMMEDIATELY.** In such a situation, depending on the magnitude of the sample pressure, leaks in the manifold might result.

**3.4 Atmospheric Pressure Sampling.** If the sample is at atmospheric pressure (or slightly negative), a sample pump will be required downstream from the analyzer. The inlet side of the pump should also be equipped with a throttle valve -- so that sample flow can be reduced to between 0.2 and 5 liters/min. If pump loading is a consideration, the inlet side of the pump will have to include a bypass path that is open to the atmosphere through a second throttle valve. The sample path and bypass path may then be balanced by manipulating the two valves, so that the sample flow is within the prescribed limits.

**UNDER NO CIRCUMSTANCES SHOULD THERE BE ANY RESTRICTIONS IN THE LINE BETWEEN THE SAMPLE POINT AND THE ANALYZER --** as a partial vacuum would then be drawn on the cell. Since the cell is a partial pressure sensitive device, any oxygen readings taken under these conditions would be erroneous and vacuums in excess of one-third of an atmosphere may damage the cell.

## 4. MAINTENANCE

**4.1 Battery Power Supply Service.** The Model 311XL is designed to be intrinsically safe, and therefore is for use ONLY when it is not connected to the AC power line. TAI suggests that an overnight recharge be accomplished every three (3) weeks of continuous use. To recharge the batteries, place the range switch in the "OFF" position and connect the power cord to a convenient outlet. **NOTE:** *The amber charge lamp (on the rear of the case) will be lit during charging process. The integral charging circuit will automatically energize and regulate the battery charging current when the switch is in the "OFF" position and the AC cord is plugged into the power line.*

**WARNING: DO NOT TURN THE RANGE SWITCH EITHER TO "BATT TEST" OR TO ANY OF THE OPERATING RANGE POSITIONS WHILE THE UNIT IS PLUGGED INTO THE POWER LINE! DOING SO MAY CAUSE THE INTEGRATED CIRCUITS TO FAIL.**

When recharging is completed, unplug the unit from the AC outlet. Turn the range switch to the "BATT TEST" position or to any operating position.

**NOTE:** The "BATT TEST" position will not give a reliable indication of the battery charge immediately after a charge cycle. Allow the unit to run for awhile before testing the batteries.

If the instrument is stored with the range switch in the "OFF" position (charge cord disconnected), the period of time between charge periods is extended from one month to four months. However, do not leave it longer than this time period.

**4.2 Routine Maintenance.** Beyond adhering to a battery recharge schedule, no routine maintenance is required, as there are no moving parts in the instrument other than the meter movement. The Micro-Fuel Cell is a sealed, modular component that should be replaced only when faulty.

**4.3 Cell Replacement.** The characteristics of the Micro-Fuel Cell are similar to those of a mercury battery in that both provide an almost constant output through their useful life, and then fall off sharply towards zero at the end. If the sample being analyzed has a low (0-2 ppm range) oxygen concentration, cell failure will probably be indicated by a sluggish recovery to low ppm readings after a calibration (exposure to a higher level of oxygen) or an elevated zero offset level (i.e. a reading  $>1/2$  ppm @ 25°C or less when a zero sample is introduced). The cell should be replaced when this recovering time becomes unacceptable (see Section 5.4 for cell replacement instructions).



To offset the possibility of not having a replacement cell available when it is needed, TAI recommends that a spare cell be purchased shortly after the instrument is placed in service, and each time the cell is replaced thereafter.

The spare cell should be carefully stored in an area that is not subject to large variations in ambient temperature (75 Deg. F nominal), and in such a way as to obviate any possibility of damage. Under no circumstances, disturb the integrity of the cell package until the cell is to be actually used.

No tools are required to replace the cell in the instrument. Simply unscrew (ccw) the plug at the bottom of the analyzer and the cell will drop out of the manifold cavity.

Remove the new cell from its package, and carefully remove the shorting device. Place the cell on the end of the manifold plug -- so that the sensing surface of the cell is in contact with the plug and the electrical contact plate end of the cell is facing upwards. Insert the cell and plug in the manifold cavity, and screw the plug back into place. Apply as much pressure as you can with your fingers, but use no tools.

After the cell has been installed, purge the instrument with an oxygen free gas (or the sample), and then proceed as directed in Section 3.1 and 3.2.1.

**4.4 Cell Warranty.** The Class B-2CXL cell employed in the Model 311XL is warranted for six (6) months of service.

With regard to spare cells, service time starts when the cell is removed from its shipping package. The customer should stock only one spare cell per instrument at a time. Do not attempt to stock- pile spare cells.

The Model 311XL should not be used in applications where CO<sub>2</sub> is a major component in the sample. Concentrations of 1,000 ppm or less will not effect the cell performance. The following page is a graph showing the effects of CO<sub>2</sub> on cell life.

If a cell was working satisfactorily, but ceases to function before the warranty period expires, the customer will receive credit, toward the purchase of a new cell.

Customer's having warranty claims must return the cell in question to the factory for evaluation, after obtained an RMA number. If it is determined that failure is due to faulty workmanship or material, the cell will be replaced at no cost to the customer.

**WARNING: Evidence of damage due to tampering or mishandling will render the cell warranty null and void.**

## 5. TRANSDUCER AND TEMPERATURE COMPENSATION

The Micro-Fuel Cell has an inherent positive temperature coefficient, the effects of which have been minimized through the implementation of a thermistor compensation circuit.

Internal electronic calibration is accomplished by TAI. However, should there be any doubt, the following procedure can be used to recalibrate the electronics. Refer to Schematic.

1. Disconnect cell.
2. Move range switch to "CAL" position.
3. Adjust R2 (designated as R2 on Schematic C70246 (C70248 for 311TCXL) and designated on the A3 PCB module assembly as R28) for  $0 \pm 1$  mV at output of A3, pin 6.
4. Verify that the offset is the same on all ranges.
5. Re-connect cell.

## 6. LEAK TESTING

If a leak is suspected in the unit, **DO NOT ATTEMPT TO TIGHTEN THE DISCONNECT FITTINGS. THE FITTINGS ARE POTTED IN EPOXY AND TIGHTENING THEM WILL BREAK THE SEALS.**

To check for leaks, TAI recommends one of the following procedures:

Procedure I:

1. Purge the instrument down as low as possible.
2. Place the vent line in water and disconnect the sample.
3. Next, disconnect the vent line and place the range switch on the X1000 range.
4. The unit should stay on the X1000 range if there are no leaks.

Procedure II:

1. Purge the instrument with Nitrogen at the sample port.
2. Note the reading once it has stabilized (at least 24 hrs. on the 0-2 ppm range) and increase the flow rate.
3. If the reading goes down, the unit, or the tubing to the unit, has a leak.

## **7. PRODUCT SPECIFICATION DATA**

**RANGES:** 0-2, 10, 100, 1000 PPM Oxygen and Cal range for air calibration

### **ACCURACY:**

Accuracy at 25°C and constant pressure after thermal equilibrium has been reached. Basic accuracy +/- 2% of full scale for all ranges except 0-2 PPM range. Accuracy for 0-2 PPM range (+/- 5% of full scale).

Accuracy over the temperature range 0-35C at constant pressure after thermal equilibrium has been reached. Basic accuracy +/- 5% of scale for all ranges except 0-2 PPM range. Accuracy for 0-2PPM range (+/- 10% of full scale).

### **SENSITIVITY:**

20ppb or better

### **REPRODUCIBILITY:**

+/- 1% AT CONSTANT TEMPERATURE

### **RESPONSE:**

90% in 90 sec. on the 0-2 PPM range with a flow rate of 2.5 SCFH.

### **SYSTEM OPERATING TEMPERATURE:**

32 – 98 DEG. F (0-35C)

### **SENSOR TYPE:**

Micro fuel cell class B-2XL

### **SYSTEM POWER REQUIREMENTS:**

100-115VAC 50/60 Hz (for battery charging only)

The system includes two sets of current limited NiCad batteries (internal).

### **WEIGHT:**

6lb (2.71 kg).

## RECOMMENDED SPARE PARTS LIST

### 311XL SERIES

| <u>QTY.</u> | <u>P/N</u>   | <u>DESCRIPTION</u>  |
|-------------|--------------|---|
| 1           | F-39         | MICRO-FUSE, 0.25 AMP., FAST-BLOW<br>(FOR 210-240 VAC)         |
| 1           | F-51         | MICRO-FUSE, 0.5 AMP., FAST-BLOW<br>(FOR 100-115 VAC)          |
| 1           | C6689 -B2CXL | MICRO-FUEL CELL, CLASS B-2CXL                                 |
| 2           | B-83256      | BATTERY   |
| 1           | L-79         | LAMP  |
| 1           | M70          | METER.  |
| 1           | B-70283      | DIAL-RANGE OF 0-2, 0-10 ppm O2 & CAL.<br>(USE WITH M70 METER) |
| 1           | A36289       | CALIBRATION KIT   |
| 1           | A205         | OP-AMP A3 (LF441)   |
| 1           | A246         | OP-AMP A1 (MAX 430)   |

A MINIMUM CHARGE IS APPLICABLE TO SPARE PARTS ORDERS.

**IMPORTANT:** Orders for replacement parts should include the part number (if available), model number, serial number, sales order number, and range/background of the analyzer for which the parts are intended.

SEND ORDERS TO: **TELEDYNE ANALYTICAL INSTRUMENTS**  
16830 CHESTNUT STREET  
CITY OF INDUSTRY, CALIF. 91749

TELEPHONE: (888) 789-8168  
(626) 934-1500  
(626) 961-9221

FAX: (626) 961-2538  
(626) 934-1651

TEC. SUPPORT: (626) 934-1673

Web: [www.teledyne-ai.com](http://www.teledyne-ai.com)

**DRAWING LIST**

**MODEL 311XL**

|         |                          |
|---------|--------------------------|
| C-70246 | SCHEMATIC                |
| D-70268 | OUTLINE                  |
| C-14627 | WIRING DIAGRAM (110 VAC) |
| C-10470 | WIRING DIAGRAM (220VAC)  |

**DRAWING LIST**

**MODEL 311TCXL**

|         |                          |
|---------|--------------------------|
| C-70248 | SCHEMATIC                |
| D-70270 | OUTLINE                  |
| C-41661 | WIRING DIAGRAM (110 VAC) |
| C-37938 | WIRING DIAGRAM (220VAC)  |

***NOTE:*** The MSDS on this material is available upon request through the Teledyne Environmental Health and Safety Coordinator. Contact at (626) 934-1592.

## Effect of CO<sub>2</sub> on B-2CXL Cell Life

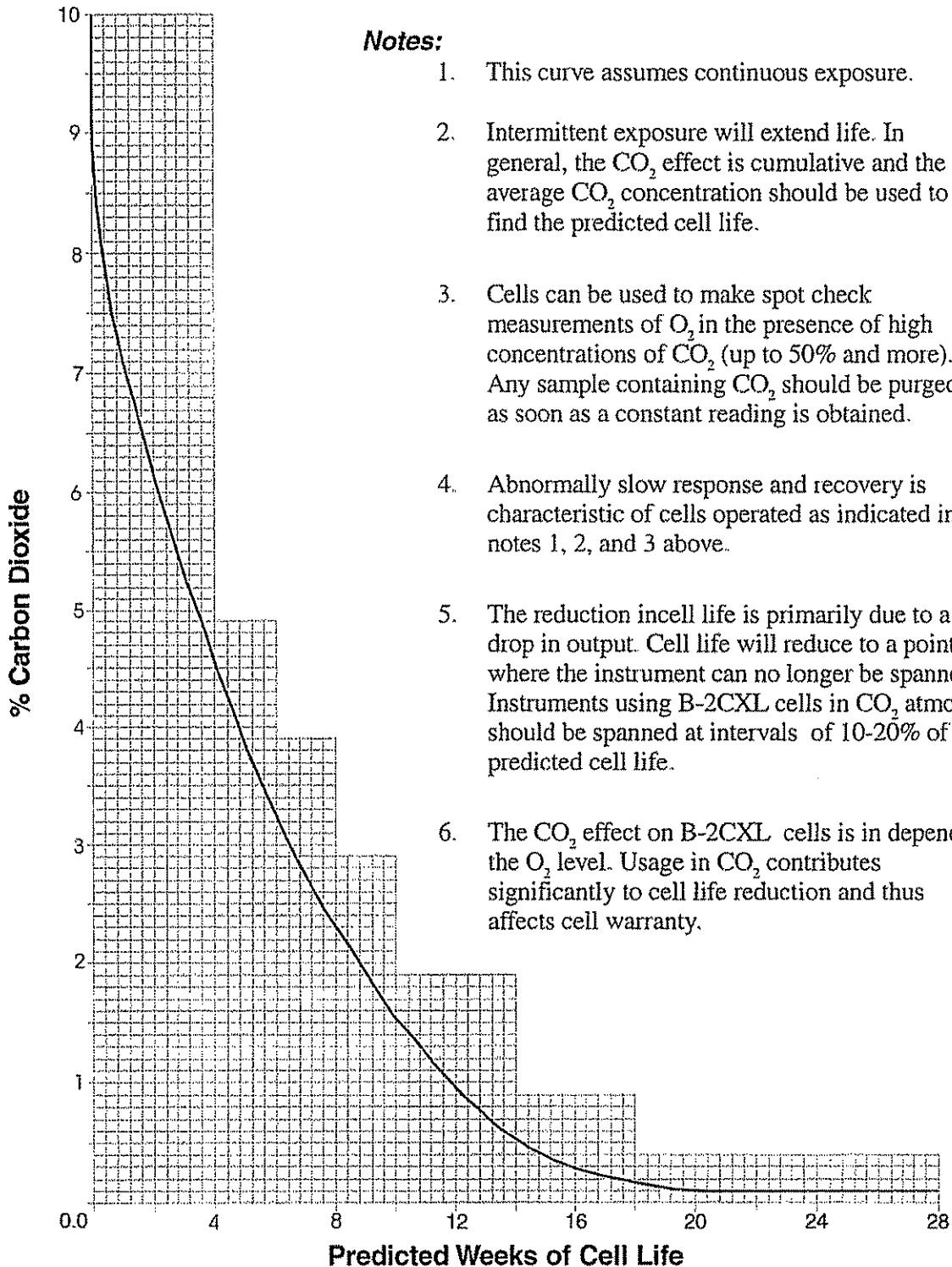

**Notes:**

1. This curve assumes continuous exposure.
2. Intermittent exposure will extend life. In general, the CO<sub>2</sub> effect is cumulative and the average CO<sub>2</sub> concentration should be used to find the predicted cell life.
3. Cells can be used to make spot check measurements of O<sub>2</sub> in the presence of high concentrations of CO<sub>2</sub> (up to 50% and more). Any sample containing CO<sub>2</sub> should be purged as soon as a constant reading is obtained.
4. Abnormally slow response and recovery is characteristic of cells operated as indicated in notes 1, 2, and 3 above.
5. The reduction in cell life is primarily due to a drop in output. Cell life will reduce to a point where the instrument can no longer be spanned. Instruments using B-2CXL cells in CO<sub>2</sub> atmospheres should be spanned at intervals of 10-20% of the predicted cell life.
6. The CO<sub>2</sub> effect on B-2CXL cells is independent of the O<sub>2</sub> level. Usage in CO<sub>2</sub> contributes significantly to cell life reduction and thus affects cell warranty.





NOTES: UNLESS OTHERWISE SPECIFIED.

- ① SEE PCB ASSEMBLY C-70220.
- ② SEE PCB ASSEMBLY A-33900.
- ③ FOR 220VAC APPLICATION, F1 IS 1/4 AMP. WIRING DIAGRAM: C-14627 (110VAC, 115 VAC) C-10470 (220VAC)

4. THE VALUES FOR R5, R6, R7, R8, AND C1 SHOWN ARE FOR STANDARD CONFIGURATION. THESE COMPONENT VALUES MAY CHANGE FOR CUSTOM RANGES. THE VALUES SHOWN ARE MAXIMUM ONLY.

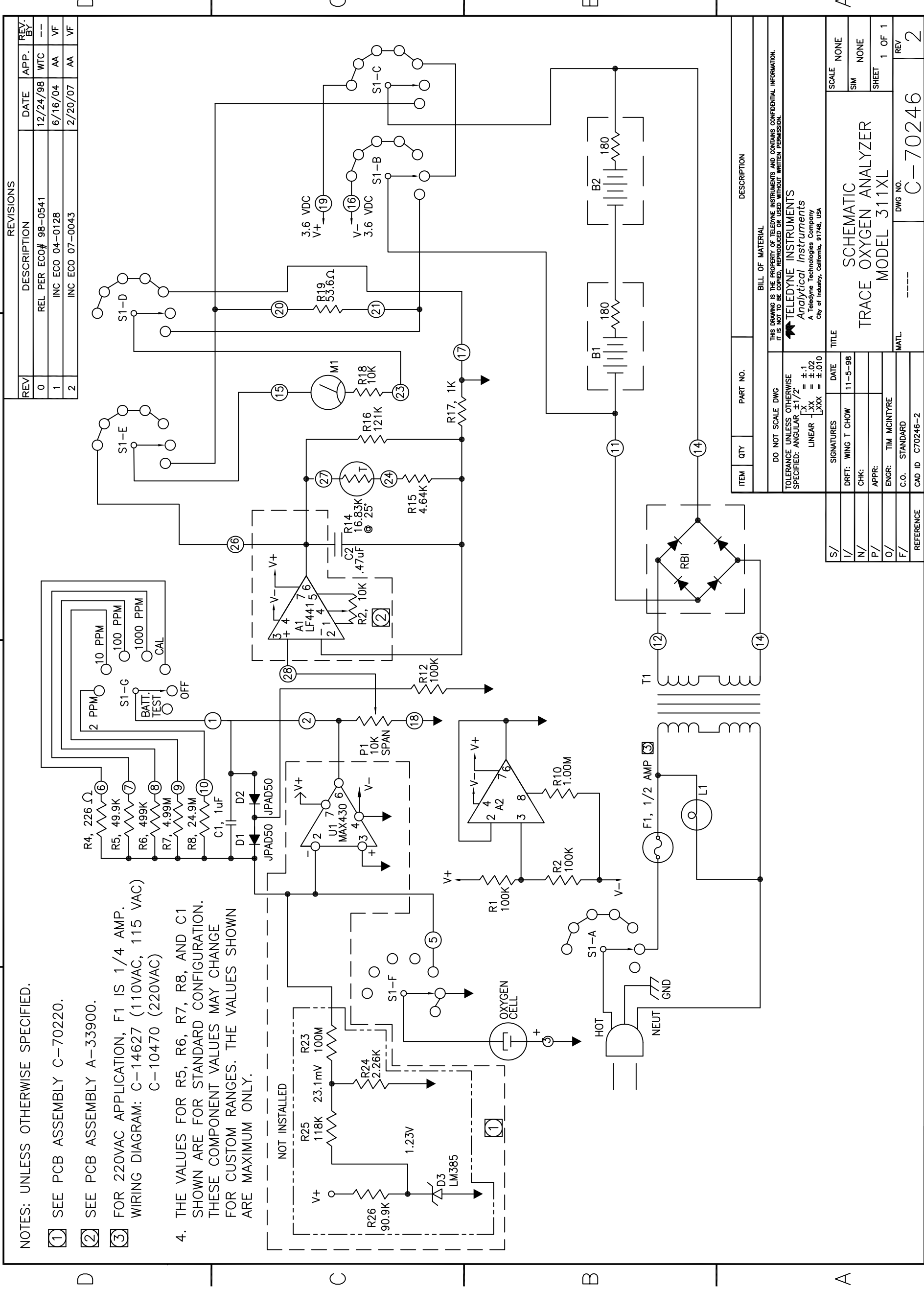

| REV. | DESCRIPTION          | DATE     | APP. | REV. BY. |
|------|----------------------|----------|------|----------|
| 0    | REL PER ECO# 98-0541 | 12/24/98 | WTC  | --       |
| 1    | INC ECO 04-0128      | 6/16/04  | AA   | VF       |
| 2    | INC ECO 07-0043      | 2/20/07  | AA   | VF       |

| ITEM   | QTY             | PART NO.        | DESCRIPTION  |
|--|-----------------|-----------------|--------------|
| BILL OF MATERIAL   |                 |                 |              |
| DO NOT SCALE DWG   |                 |                 |              |
| TOLERANCE UNLESS OTHERWISE SPECIFIED: ANGULAR ±1/2°  |                 |                 |              |
| LINEAR .XX = ±.1<br>.XXX = ±.02<br>XXX = ±.010   |                 |                 |              |
| THIS DRAWING IS THE PROPERTY OF TELEDYNE INSTRUMENTS AND CONTAINS CONFIDENTIAL INFORMATION. IT IS NOT TO BE COPIED, REPRODUCED OR USED WITHOUT WRITTEN PERMISSION. |                 |                 |              |
| TELEDYNE INSTRUMENTS<br>Analytical Instruments<br>A Teledyne Technologies Company<br>City of Industry, California, 91748, USA                                      |                 |                 |              |
| SIGNATURES   | DATE            | TITLE           | SCALE        |
| DRFT: WING T CHOW  | 11-5-98         |                 | NONE         |
| CHK:   |                 |                 | SIM          |
| APPR:  |                 |                 | NONE         |
| ENGR: TIM MCINTYRE   |                 |                 | SHEET 1 OF 1 |
| C.O. STANDARD  |                 |                 | REV 2        |
| REFERENCE  | CAD ID C70246-2 | DWG NO. C-70246 |              |



NOTES: UNLESS OTHERWISE SPECIFIED.

- INSTRUMENT IS 5 5/8" DEEP. (142.8mm)

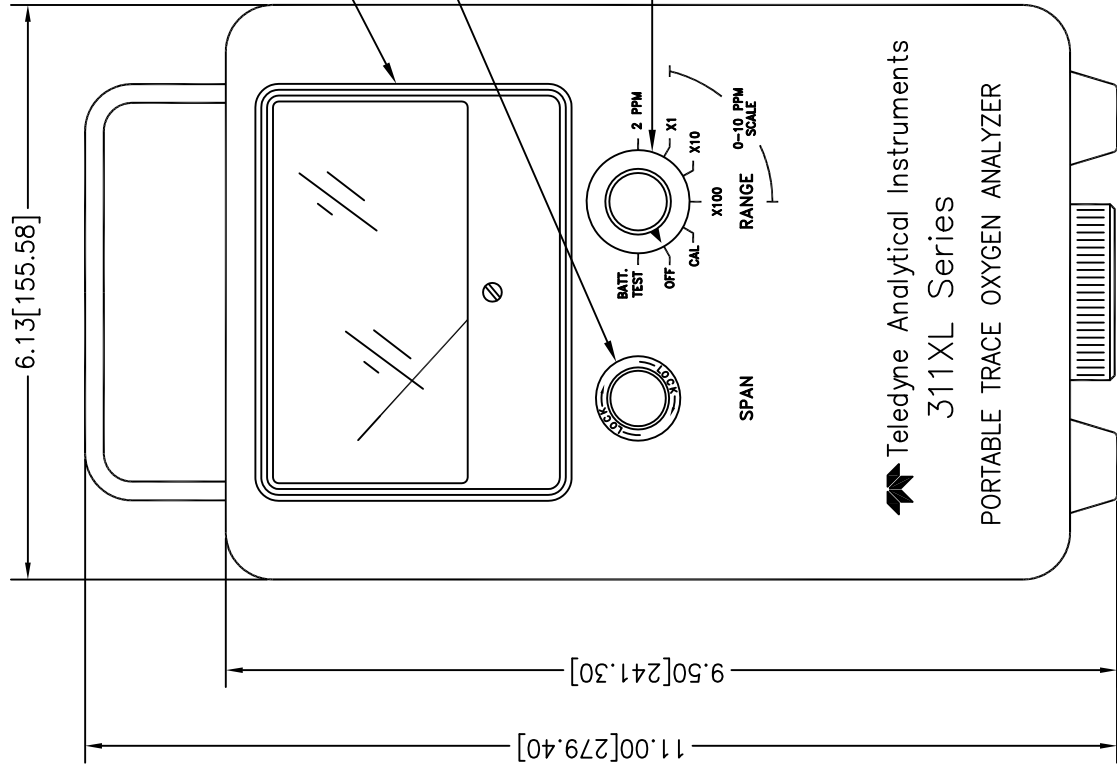

PRECISION 0.5% LINEARITY O<sub>2</sub> INDICATING METER.

CALIBRATION CONTROL USED TO STANDARDIZE THE INSTRUMENT AGAINST A KNOWN CONCENTRATION OF OXYGEN. USING THIS CONTROL, THE CAL. POSITION OF THE RANGE SWITCH, THE CAL. MARK ON THE METER DIAL, AND ATMOSPHERIC AIR, THE INSTRUMENT MAY BE CALIBRATED WITHOUT A SPECIAL SPAN GAS.

RANGE SELECTOR SWITCH. ANALYSIS RANGES OF FROM 0-2PPM TO 0-0.1% OXYGEN IN DECADE STEPS AND A BATTERY TEST POSITION. FEATURES AN AIR CALIBRATION POSITION (20.9% OXYGEN) TO OFFSET THE NEED FOR A SPECIAL CALIBRATION GAS.

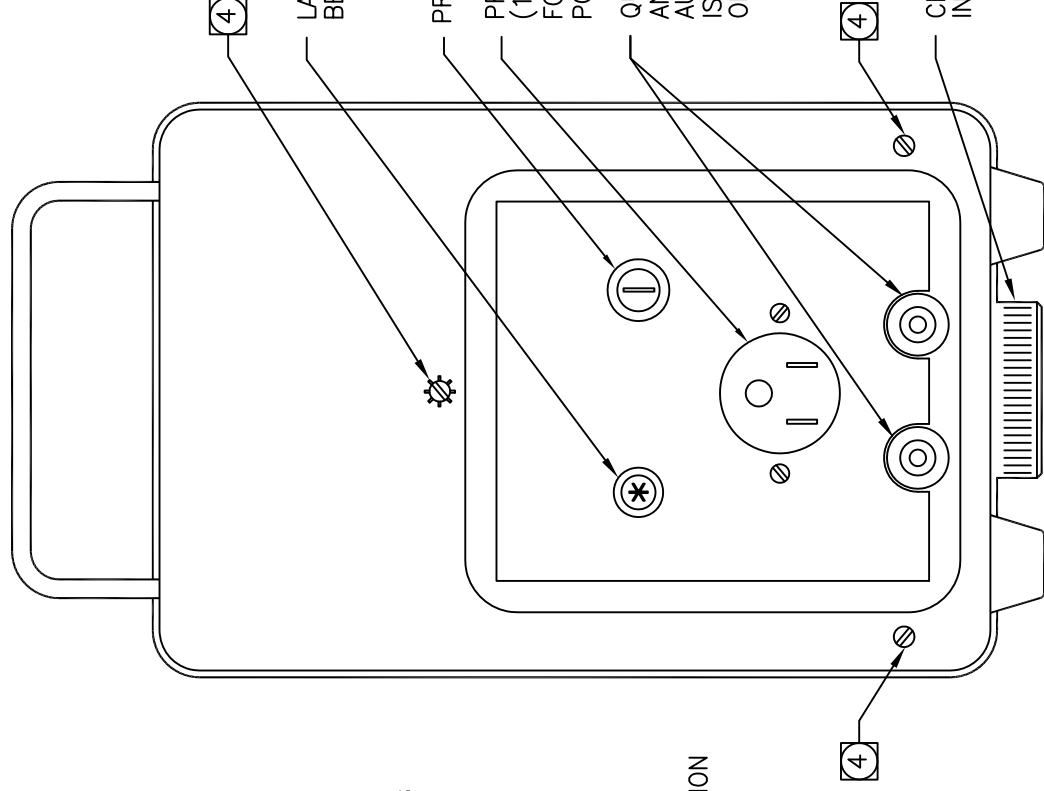

LAMP TO INDICATE THAT BATTERY IS BEING CHARGED.

PROTECTIVE FUSE (CHARGING CIRCUIT ONLY).  
PRIMARY POWER RECEPTACLE (100 - 125V OR 220V, 50-60 Hz, FOR BATTERY CHARGING ONLY). MATING POWER CORD ACCOMPANIES INSTRUMENT.

QUICK DISCONNECT SAMPLE FITTING FEATURES AN INTEGRAL SHUTOFF VALVE THAT CLOSES AUTOMATICALLY WHEN THE MATING FITTING IS WITHDRAWN. SAMPLE MAY BE INTRODUCED OR VENTED FROM EITHER FITTING.

CELL ACCESS PORT. USED TO REMOVE OR INSTALL THE MICRO-FUEL CELL.

IMPORTANT OPERATIONAL NOTES

1. ALWAYS CONNECT THE VENT FITTING FIRST, AND THEN THE SAMPLE SOURCE FITTING. WHEN DISCONNECTING, ALWAYS DISCONNECT SAMPLE SOURCE FITTING FIRST, AND THEN THE VENT FITTING. PRESSURISING THE CELL MAY DAMAGE IT AND VOID THE WARRANTY.

2. BEFORE MAKING ANY CONNECTIONS TO THE INSTRUMENT, ESTABLISH A FLOWRATE IN THE SAMPLE LINE OF FROM 0.1-10 LITERS/MIN USING A THROTTLE VALVE BETWEEN THE POSITIVE PRESSURE SOURCE AND THE INSTRUMENT INLET (1-2 LITERS/MIN IS SUGGESTED).

3. TO CALIBRATE THE INSTRUMENT WITH AN AIR SAMPLE, PLACE THE RANGE SWITCH ON THE CAL. POSITION, INSTALL AN OPEN FITTING IN ONE SAMPLE PORT, AND A PLASTIC TUBE EQUIPPED FITTING IN THE OTHER PORT. GENTLY DRAW AIR INTO THE INSTRUMENT BY SUCKING ON THE PLASTIC TUBE. NOTE THE METER READING. WHEN IT STABILIZES UNLOCK THE SPAN CONTROL AND ADJUST IT UNTIL THE METER POINTER IS IN COINCIDENCE WITH THE CAL. MARK ON THE METER SCALE, AND RELOCK THE SPAN CONTROL. RE-INTRODUCE SAMPLE GAS (OR A LOW PPM OXYGEN GAS) IMMEDIATELY

④ OUTER CASE 1/4 TURN FASTENER (ONE OF THREE).

| REV | DESCRIPTION            | DATE     | APP. | REV. BY |
|-----|------------------------|----------|------|---------|
| 0   | REL. PER. ECO# 98-0541 | 12/24/98 | WTC  | --      |

| ITEM   | QTY | PART NO. | DESCRIPTION |
|--|-----|----------|-------------|
| <p>DO NOT SCALE DWG<br/>TOLERANCE UNLESS OTHERWISE SPECIFIED: ANGULAR ±1/2°<br/>LINEAR ±.005<br/>±.010</p>   |     |          |             |
| <p>THIS DRAWING IS THE PROPERTY OF TELEDYNE ANALYTICAL INSTRUMENTS AND CONTAINS CONFIDENTIAL INFORMATION. IT IS NOT TO BE COPIED, REPRODUCED OR USED WITHOUT WRITTEN PERMISSION.</p> |     |          |             |
| <p>TELEDYNE ANALYTICAL INSTRUMENTS<br/>Analytical Instruments<br/>A Teledyne Instrument Company<br/>CITY OF INDUSTRY, CALIFORNIA 91716</p>   |     |          |             |
| SIGNATURES   |     |          | TITLE       |
| DRFT: WING T CHOW  |     |          | 11-6-98     |
| CHK:   |     |          |             |
| APPR:  |     |          |             |
| ENGR: TIM MCINTYRE   |     |          |             |
| S.O. STANDARD  |     |          |             |
| CAD ID: D70268-0   |     |          |             |
| REFERENCE  |     |          |             |
| SCALE 1:1  |     |          |             |
| SIM D-9271   |     |          |             |
| SHEET 1 OF 1   |     |          |             |
| DWG NO. D-70268  |     |          | REV 0       |







| REV. | DESCRIPTION | DATE     | APP. | REV. |
|------|-------------|----------|------|------|
| 8    | ECO# 94-595 | 10-20-94 | JML  | M.V. |
| 9    | ECO# 96-251 | 3-22-96  | JZP  | M.V. |

NOTES: UNLESS OTHERWISE SPECIFIED.  
 - SEE B-14463 SCHEMATIC  
 ① ON P/N S236 MANUFACTURED BY GRAYHILL, SLIDER IS LOCATED BETWEEN POSITIONS 3 & 4 ON ALL DECKS "A" THRU "C".

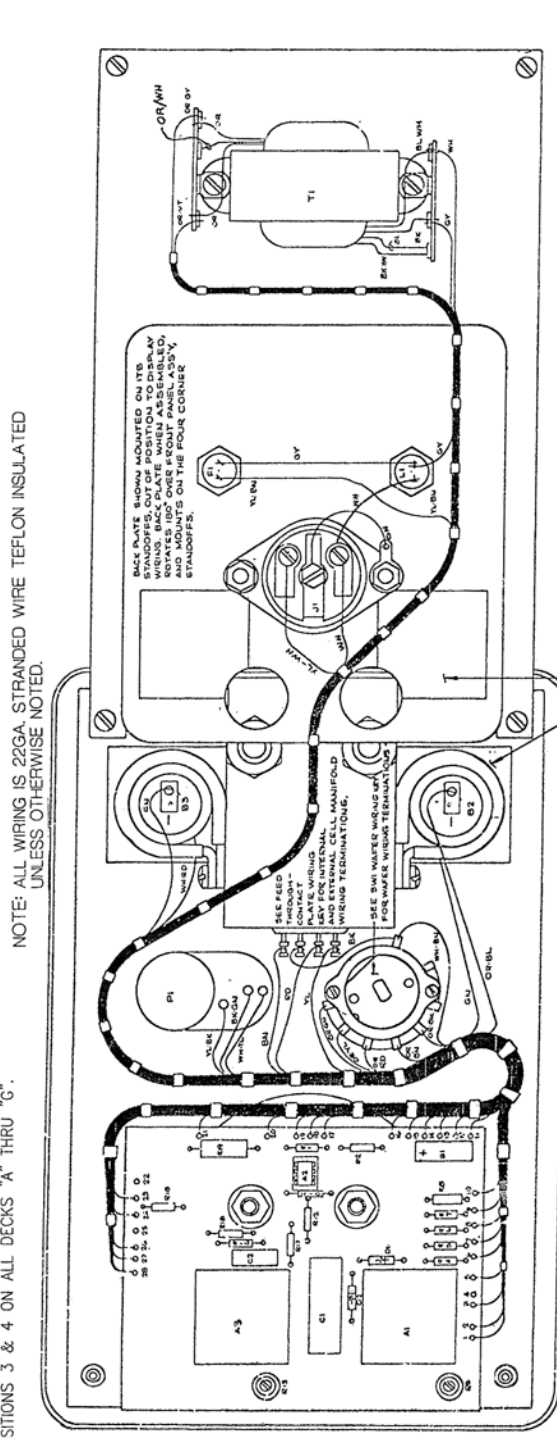

NOTE: ALL WIRING IS 22GA. STRANDED WIRE TEFLON INSULATED UNLESS OTHERWISE NOTED.

BACK PLATE SHOWN MOUNTED ON ITS STANDOFFS, OUT OF POSITION TO DISPLAY SWITCHES FROM ASSEMBLY. ROTATES 180° OVER KNOBS AND IS MOUNTED ON THE FOUR CORNER STANDOFFS.

SEE FEED THROUGH PLATE WIRING DECK FOR INTERNAL WIRING TERMINATIONS.

SEE SWI WAFER WIRING DECK FOR WAFER WIRING TERMINATIONS.

NOTE: CEMENT 4 PADS OF 1/4" MICARTA TO CHASSIS TO AVOID BATTERIES FROM SHORTING.

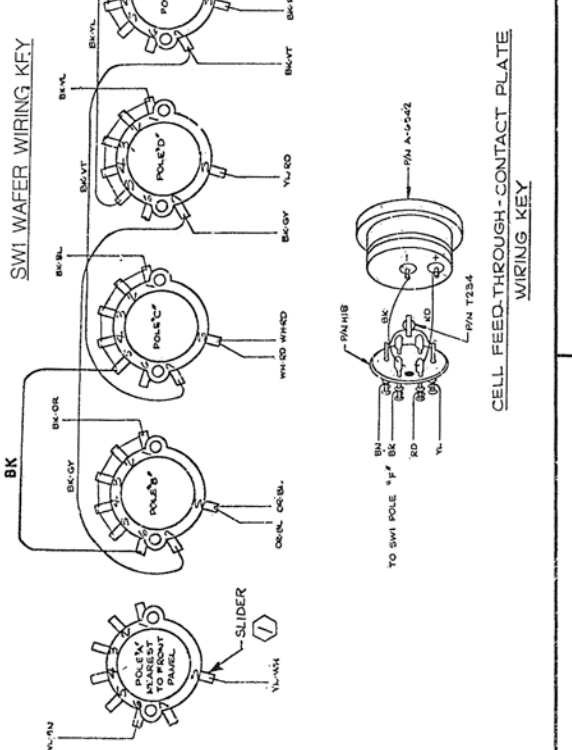

TO SWI POLE "P" (PIN A-15-42)

CELL FEED-THROUGH-CONTACT PLATE WIRING KEY

| ITEM  | QTY | PART NO. | DESCRIPTION |
|---|-----|----------|-------------|
| BILL OF MATERIAL                                    |     |          |             |
| DO NOT SCALE DWG                                    |     |          |             |
| TOLERANCE UNLESS OTHERWISE SPECIFIED: ANGULAR ±1/2° |     |          |             |
| LINEAR ±.005  |     |          |             |
| DATE: 4-15-76                                       |     |          |             |
| DRAWN BY: H. ULLMAN                                 |     |          |             |
| CHECKED BY: J.M. LAUER                              |     |          |             |
| APP'D BY: J.M. LAUER                                |     |          |             |
| ENGR. BY: J.M. LAUER                                |     |          |             |
| S.O. NO.:   |     |          |             |
| DWG. NO. C-10470                                    |     |          |             |
| REV. 9  |     |          |             |

| REV. | DESCRIPTION                  | DATE    | APP. | REV. |
|------|------------------------------|---------|------|------|
| 1    | SCALE                        | 4-15-76 | JML  | M.V. |
| 2    | MODEL 311-1X                 |         |      |      |
| 3    | TRACE O2 ANALYZER            |         |      |      |
| 4    | WIRING DIAGRAM 220V, 50/60HZ |         |      |      |