

Use and Disclosure of Data
Information contained herein is classified as EAR99 under the
U.S. Export Administration Regulations.
Export, reexport or diversion contrary to U.S. law is prohibited.

OPERATING INSTRUCTIONS FOR

Model 9060L

Percent Oxygen Analyzer



P/N M77713

ECO:



DANGER



Toxic gases and or flammable liquids may be present in this monitoring system.
Personal protective equipment may be required when servicing this instrument.
Hazardous voltages exist on certain components internally which may persist for a time even after the power is turned off and disconnected.
Only authorized personnel should conduct maintenance and/or servicing.
Before conducting any maintenance or servicing, consult with authorized supervisor/manager.

DECLARATION OF CONFORMITY

APPLICATION OF COUNCIL DIRECTIVE : 89/336/EEC
73/23/EEC

STANDARDS TO WHICH CONFORMITY IS DECLARED : EN55011 Class A Group I
EN61010-1
EN50082-2

MANUFACTURER'S NAME : TELEDYNE ANALYTICAL INSTRUMENTS

MANUFACTURER'S ADDRESS : 16830 Chestnut Street
City of Industry, CA 91748
U.S.A.

TYPE OF EQUIPMENT : Oxygen Analyzer

EQUIPMENT CLASS : ISM Class A Group 1

MODEL NUMBER : 9060L

I, THE UNDERSIGNED, HEREBY DECLARE THAT THE EQUIPMENT SPECIFIED ABOVE CONFORMS TO THE ABOVE STANDARD(S) PER 89/336/EEC AND 73/23/EEC.

SIGNATURE: 

FULL NAME: Angel Alegria

POSITION: New Products Manager

DATE: 3/30/06

PLACE: City of Industry, CA

Copyright © 2005 Teledyne Instruments/ Analytical Instruments

All Rights Reserved. No part of this manual may be reproduced, transmitted, transcribed, stored in a retrieval system, or translated into any other language or computer language in whole or in part, in any form or by any means, whether it be electronic, mechanical, magnetic, optical, manual, or otherwise, without the prior written consent of Teledyne Instruments/ Analytical Instruments, 16830 Chestnut Street, City of Industry, CA 91749-1580.

Warranty

This equipment is sold subject to the mutual agreement that it is warranted by us free from defects of material and of construction, and that our liability shall be limited to replacing or repairing at our factory (without charge, except for transportation), or at customer plant at our option, any material or construction in which defects become apparent within one year from the date of shipment, except in cases where quotations or acknowledgements provide for a shorter period. Components manufactured by others bear the warranty of their manufacturer. This warranty does not cover defects caused by wear, accident, misuse, neglect or repairs other than those performed by TI/AI or an authorized service center. We assume no liability for direct or indirect damages of any kind and the purchaser by the acceptance of the equipment will assume all liability for any damage which may result from its use or misuse.

We reserve the right to employ any suitable material in the manufacture of our apparatus, and to make any alterations in the dimensions, shape or weight of any parts, in so far as such alterations do not adversely affect our warranty.

Important Notice

This instrument provides measurement readings to its user, and serves as a tool by which valuable data can be gathered. The information provided by the instrument may assist the user in eliminating potential hazards caused by his process; however, it is essential that all personnel involved in the use of the instrument or its interface, with the process being measured, be properly trained in the process itself, as well as all instrumentation related to it.

The safety of personnel is ultimately the responsibility of those who control process conditions. While this instrument may be able to provide early warning of imminent danger, it has no control over process conditions, and it can be misused. In particular, any alarm or control systems installed must be tested and understood, both as to how they operate and as to how they can be defeated. Any safeguards required such as locks, labels, or redundancy, must be provided by the user or specifically requested of TI/AI at the time the order is placed.

Therefore, the purchaser must be aware of the hazardous process conditions. The purchaser is responsible for the training of personnel, for providing hazard warning methods and instrumentation per the appropriate standards, and for ensuring that hazard warning devices and instrumentation are maintained and operated properly.

Teledyne Instruments/ Analytical Instruments, the manufacturer of this instrument, cannot accept responsibility for conditions beyond its knowledge and control. No statement expressed or implied by this document or any information disseminated by the manufacturer or its agents, is to be construed as a warranty of adequate safety control under the user's process conditions.



Specific Model Information

Instrument Serial Number: _____

Instrument Range: _____

Calibrated for: _____

Background Gas: _____

Zero Gas: _____

Span Gas: _____

Safety Messages

Your safety and the safety of others is very important. We have provided many important safety messages in this manual. Please read these messages carefully.

A safety message alerts you to potential hazards that could hurt you or others. Each safety message is associated with a safety alert symbol. These symbols are found in the manual and inside the instrument. The definition of these symbols is described below:



GENERAL WARNING/CAUTION: Refer to the instructions for details on the specific danger. These cautions warn of specific procedures which if not followed could cause bodily injury and/or damage the instrument.



CAUTION: HOT SURFACE WARNING: This warning is specific to heated components within the instrument. Failure to heed the warning could result in serious burns to skin and underlying tissue.



WARNING: ELECTRICAL SHOCK HAZARD: Dangerous voltages appear within this instrument. This warning is specific to an electrical hazard existing at or nearby the component or procedure under discussion. Failure to heed this warning could result in injury and/or death from electrocution.



Technician Symbol: All operations marked with this symbol are to be performed by qualified maintenance personnel only.

No
Symbol

NOTE: Additional information and comments regarding a specific component or procedure are highlighted in the form of a note.



CAUTION: THE ANALYZER SHOULD ONLY BE USED FOR THE PURPOSE AND IN THE MANNER DESCRIBED IN THIS MANUAL.

IF YOU USE THE ANALYZER IN A MANNER OTHER THAN THAT FOR WHICH IT WAS INTENDED, UNPREDICTABLE BEHAVIOR COULD RESULT POSSIBLY ACCOMPANIED WITH HAZARDOUS CONSEQUENCES.

This manual provides information designed to guide you through the installation, calibration operation and maintenance of your new analyzer. Please read this manual and keep it available.

Occasionally, some instruments are customized for a particular application or features and/or options added per customer requests. Please check the front of this manual for any additional information in the form of an Addendum which discusses specific information, procedures, cautions and warnings that may be peculiar to your instrument.

Manuals do get lost. Additional manuals can be obtained from TI/AI at the address given in the Appendix. Some of our manuals are available in electronic form via the internet. Please visit our website at: www.teledyne-ai.com.

Table of Contents

List of Figures	viii
List of Tables	ix
Introduction	11
1.1 Overview	11
1.2 Main Features of the Analyzer	11
1.3 Front Panel Description	12
1.4 Rear Panel Description	13
Operational Theory	15
2.1 Introduction	15
2.2 Oxygen Probe, Sensor, and Heater	15
2.2.1 Probe Configuration	17
2.2.2 The Zirconia Sensor	18
2.2.3 Heater	19
2.3 Applications Not at Atmospheric Pressure	20
2.4 Sensor Impedance	20
2.5 Electronics	20
2.5.1 General	20
2.5.2 Signal Processing	21
Installation	23
3.1 Unpacking the Analyzer	23
3.2 Control Unit Installation	23
3.3 9060L Oxygen Probe Installation	23
3.4 Electrical Connections	25
3.4.1 Primary Input Power	25
3.4.2 Analog Outputs	26
3.4.3 Alarm Relays	26

Percent Oxygen Analyzer

3.4.1 Oxygen Probe Connections	28
3.5 Installation Checklist	29
Operation	31
4.1 Introduction	31
4.2 Using the Function and Data Entry Buttons	32
4.3 Setting the Analysis Ranges	32
4.3.1 HI Range	33
4.3.2 LO Range	33
4.4 Setting the Alarm Setpoints	33
4.4.1 Set Alarm 1 (HI alarm)	33
4.4.2 Set Alarm 2 (LO alarm)	34
4.4.3 Sensor Fail Alarm	34
4.5 Selecting a Fixed Range or Autoranging	34
4.6 Oxygen Calibration	35
4.6.1 Span Calibration	35
4.6.2 Air Calibration	37
4.7 Supplementary Information	37
4.8 Probe Temperature	37
4.8.1 Low Temperature	38
4.8.2 Open Thermocouple	38
4.9 Error Messages	38
Maintenance.....	41
5.1 Replacing the Fuse	41
Appendix	43
A.1 Specifications	43
A.2 Probe Specifications	44
A.3 Spare Parts List	45
Email: ask_tai@teledyne.comA.4 Reference Drawing	45
A.4 Reference Drawing	46
A.5 Probe or Sensor EMF Tables	46
Index.....	49

List of Figures

Figure 1-1: Front Panel	12
Figure 1-2 Rear Panel	14
Figure 2-1: Model 9060L Oxygen Probe	16
Figure 2-2: Model 9060L Probe.....	17
Figure 2-3: Internal Structure of the Zirconia Sensor and Probe ...	18
Figure 2-3: Signal Processing Block Diagram	21
Figure 3-1: Oxygen Probe Mounting	25
Figure 3-2: Model 9060L Rear panel.....	26
Figure 3-3: Contact ID for FAILSAFE Relay Operation	27
Figure 3-4: Model 9060L Heated Probe Cable Connection.....	28
Figure 3-5: Connections to Probe	29
Figure 4-1: Front Panel Controls and Indicators.....	31
Figure 4-2: Calibration Port on Probe Head	35
Figure 5-1: AC Fuse Replacement.....	41

Percent Oxygen Analyzer

List of Tables

Table 2-1: Probe Options	17
--------------------------------	----

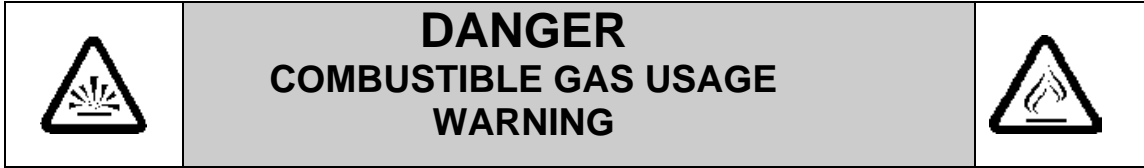

This is a general purpose instrument designed for use in a non-hazardous area. It is the customer's responsibility to ensure safety especially when combustible gases are being analyzed since the potential of gas leaks always exist.

The customer should ensure that the principles of operating this equipment are well understood by the user. Misuse of this product in any manner, tampering with its components, or unauthorized substitution of any component may adversely affect the safety of this instrument.

Since the use of this instrument is beyond the control of Teledyne Instruments/ Analytical Instruments, referred as TI/AI, no responsibility by TI/AI, its affiliates, and agents for damage or injury from misuse or neglect of this equipment is implied or assumed.

Introduction

1.1 Overview

The Teledyne Instruments/ Analytical Instruments (TI/AI) Model 9060L is a microprocessor-based percent oxygen analyzer for real-time measurement of the percent of oxygen in inert gases, or in a wide variety of gas mixtures. It features simple operation, fast response, and a compact, rugged construction. Typical applications of the Model 9060L are monitoring kilns, boilers, and flue gas at temperature from ambient up to 1400°C (2550°F).

1.2 Main Features of the Analyzer

The main features of the analyzer include:

- High resolution, accurate readings of oxygen content from 0-1 % through 0-100 % O₂. Large, bright, light-emitting-diode meter readout.
- Simple pushbutton controls.
- State of the art zirconia sensor.
- Longer life probes with greater resistance to thermal shock and mechanical damage during installation and start-up.
- Fast response and recovery time.
- Microprocessor based electronics: 8-bit CMOS microprocessor with on-board RAM and 16 KB ROM.
- Two user selectable ranges (from 0-1% through 0-100%) allow best match to user's process and equipment.
- Air-calibration range for convenient spanning at 20.9 %.
- Operator can select autoranging, which allows the analyzer to automatically select the proper preset range for a given measurement, or lock the analyzer onto a single range.

- Two concentration alarms with adjustable setpoints.
- A failure alarm.
- Three analog outputs: two for measurement (0–10VDC, and negative ground 4–20 mA DC) and one for range identification (0-10VDC).
- Compact and rugged control unit with flush-panel case. Designed for indoor use.

1.3 Front Panel Description

All controls and displays except the power switch are accessible from the front panel. See Figure 1-1. The front panel has seven pushbutton membrane switches, a digital meter, and an alarm indicator LED for operating the analyzer. These features are described briefly here and in greater detail in Chapter 4, *Operation*.

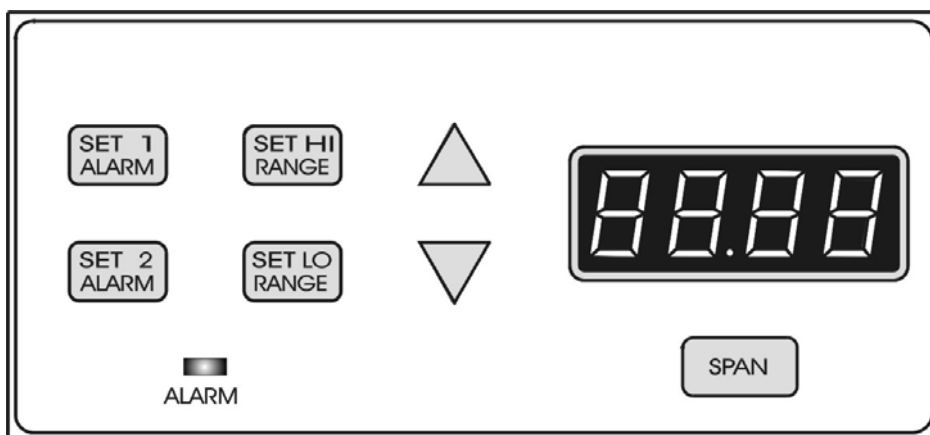

Figure 1-1: Front Panel

Function Keys: Seven pushbutton membrane switches are used to select the function performed by the analyzer:

- **Set Alarm 1** Sets the concentration at which alarm 1 activates upon rising above the threshold (HI alarm).

- **Set Alarm 2** Sets the concentration at which alarm 2 activates upon dropping below the threshold (LO alarm).
- **Set HI Range** Set the high analysis range for the instrument (up to 0-100%).
- **Set LO Range** Set the low analysis range for the instrument (down to 0-1%).
- **Span** Span calibrate the analyzer.

Data Entry Keys: Two pushbutton membrane switches are used to manually change measurement parameters of the instrument as they are displayed on the LED meter readout:

- **Up Arrow** Increment values of parameters upwards as they are displayed on the LED readout.
- **Down Arrow** Increment values of parameters downwards as they are displayed on the LED readout.

Digital LED Readout: The digital display is a LED device that produces large, bright, 7-segment numbers that are legible in any lighting environment. It has two functions:

- **Meter Readout** As the meter readout, it displays the oxygen concentration currently being measured.
- **Measurement Parameters Readout** The parameter readout displays user-defined alarm setpoints, ranges, span calibration point when they are being checked or changed, and probe temperature on demand.

1.4 Rear Panel Description

The rear panel contains the electrical input and output connectors. The connectors are described briefly here and in detail in the *Installation* chapter of this manual.

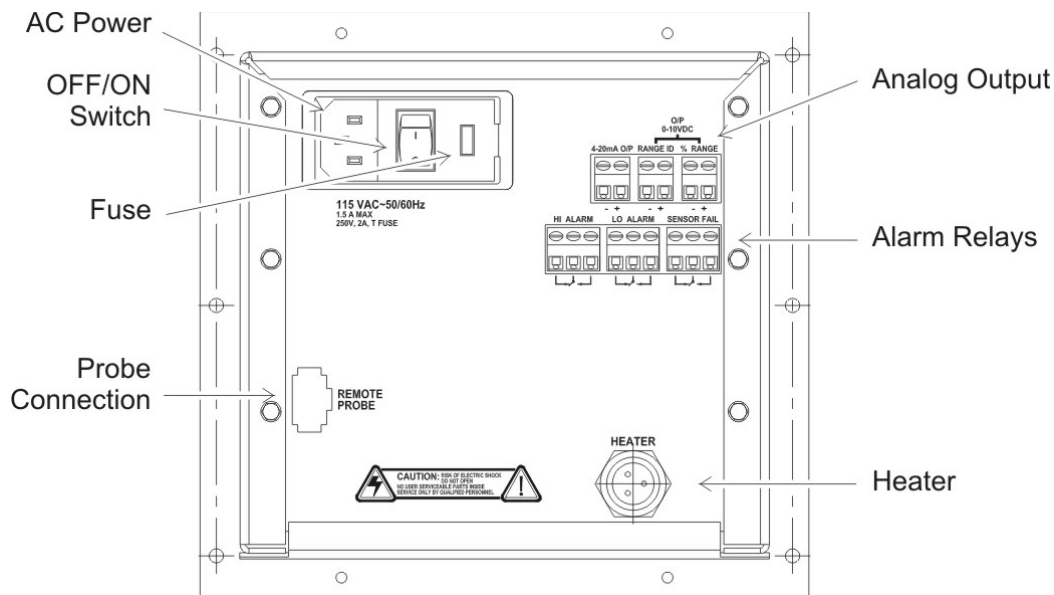

Figure 1-2 Rear Panel

- Power Connection** 110 VAC at 50/60 Hz. The connector housing includes the fuse holder and the power switch. (220VAC is optional via setting an internal switch).
Fuse Holder: Replacing the fuse is described in Chapter 5, Maintenance.
I/O Power Switch: Turns the instrument power ON (1) or OFF (0).
- Analog Outputs** 0–10 VDC concentration output.
 0–10 VDC range ID (or optional overrange) output.
 4–20 mA DC concentration output, negative ground.
- Alarm Connections** Alarm 1 (HI alarm), Alarm 2 (LO alarm), and Probe Failure Alarm connections.
- Sensor Connector** For connecting the probe's Oxygen sensor.
- Heater Connector** For connecting the probe's heater

Operational Theory

2.1 Introduction

The analyzer is composed of two subsystems:

1. Oxygen probe
2. Control unit with signal processing, display and controls

The oxygen probe can be heated or unheated. It delivers the sample gas to a state-of-the-art zirconium sensor which translates the amount of oxygen present into a millivolt output.

The control unit processes the sensor output and translates it into electrical concentration, range, and alarm outputs, and a percent oxygen meter readout. It contains a micro-controller that manages all signal processing, input/output, and display functions for the analyzer.

2.2 Oxygen Probe, Sensor, and Heater

TI/AI oxygen probes and sensors employ state-of-the-art zirconia sensors and advanced materials. They provide the following benefits:

- Improved control due to fast response time—typically less than four seconds.
- Cost-efficient design provides improved reliability.
- Longer-life probes with greater resistance to corrosion from sulphur and zinc contaminants in a flue gas.
- Low cost replacement reduces maintenance.
- Reduced probe breakage due to greater resistance to thermal shock and mechanical damage during installation and startup.

The 9060L probes or sensors are simple to install and maintain. All models provide direct measurement of oxygen level. Figure 2-1 shows a typical oxygen probe. Probe specifications are listed in the Appendix of this manual and installation is covered in Section 3.

All Teledyne oxygen probe or sensors are designed and manufactured to exacting standards of performance and reliability and are the result of extensive research and development. Teledyne Analytical Instruments provides worldwide application and after sales support for its oxygen probes, sensors and analyzers.

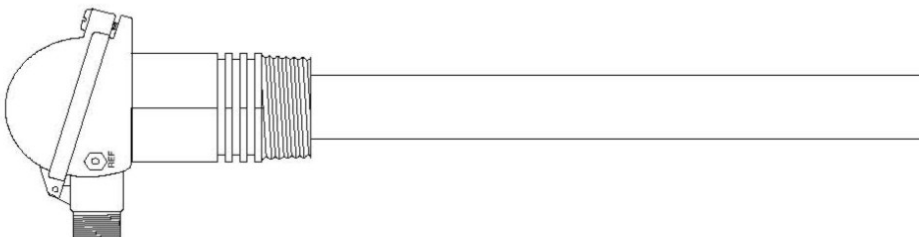

Figure 2-1: Model 9060L Oxygen Probe

The probe assembly provides a means of exposing the zirconia sensor to the atmosphere to be measured with sensor. It also provides for means of interfacing the sensor, thermocouple and heater wires with the control unit. Reference air is fed via the top plug for unheated probes or by a separate gas thread connection for heated probes. Connections are provided on probes for an in-situ gas calibration check. If required, an air purge can be admitted via the calibration gas check entry. The outer sheath of probes is either metal or ceramic, depending on the application. Calibration check can be achieved on 9060LEX sensors using a three way solenoid which blocks the sample and at the same time admits a calibration gas to the sensor. As mentioned above, probe purging for removing any dust build up can be achieved in the same way.

In-situ zirconia oxygen probes will give a lower oxygen reading than a sampled gas measurement on a chromatograph or paramagnetic analyzer because the flue gas contains a significant level of water vapor and a sampling system removes the water vapor through condensation. The oxygen content then appears as a higher percentage of the remaining gas. For example: If the gas contained five parts oxygen and fifteen parts moisture, removing the moisture would leave the oxygen at 5.88%. This phenomena will depend on the fuel and the completeness of combustion. They are common to all zirconia oxygen sensors.

Probes of 1000 mm (40”) normally have sufficient length for any installation. Customers requiring probes longer than 1500 mm (59”) are supplied with a flow guide tube that uses the flue velocity to pull flue gas through a filter at the sensing tip and exhaust it near the flue wall.

2.2.1 Probe Configuration

The probe can be configured in a variety of ways to suit the analytical environment. Figure 2-1 shows the most common configurable items of the probe. Not indicated is the actual thermocouple sensing element, however, see Table 2-1. You can choose:

1. Probe insertion length (from process end of mounting thread to probe sensing tip). See Figure 2-2.
2. Mounting thread (process connection), BST or NPT (for size of thread refer to specifications).
3. Lagging extension length, if required.

Table 2-1 indicates typical probe options.

Table 2-1: Probe Options

Probe Length	Thermocouple	Sheath	Thread
250 mm (10”)	Type K max 900°C (1560°F)	316 SS max 850°C (1560°F) Inconel The Inconel option has all inconel wetted parts except for the ceramic sensor and viton ‘o’ rings	BST or NPT
350 mm (14”)			
500 mm (20”)			
750 mm (30”)			
1000 mm (40”)			

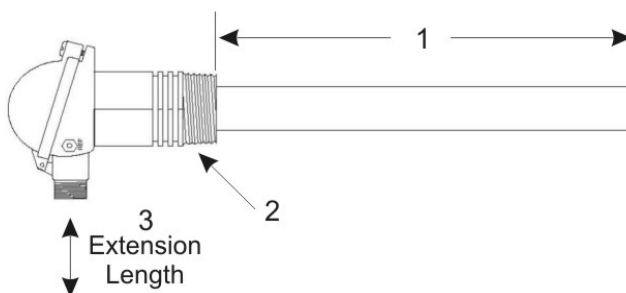

Figure 2-2: Model 9060L Probe

2.2.2 The Zirconia Sensor

Input to the analyzer is obtained from a solid electrolyte oxygen probe containing a zirconia element and thermocouple. The probe is designed to be inserted into a boiler or furnace exit gas flue or similar process. The 9060LEX sensor is designed to be installed outside of the flue or process. Sampling lines and filters are not required for in-situ probes but they are required for 9060LEX sensors. When a sampling line is required, the gas typically flows to the sensor under process pressure. In applications where the process pressure is negative or neutral, a suction pump will be required. A reference air pump is **not** provided in the Model 9060L Oxygen Analyzer. The internal construction of a probe or sensor is shown in Figure 2-3.

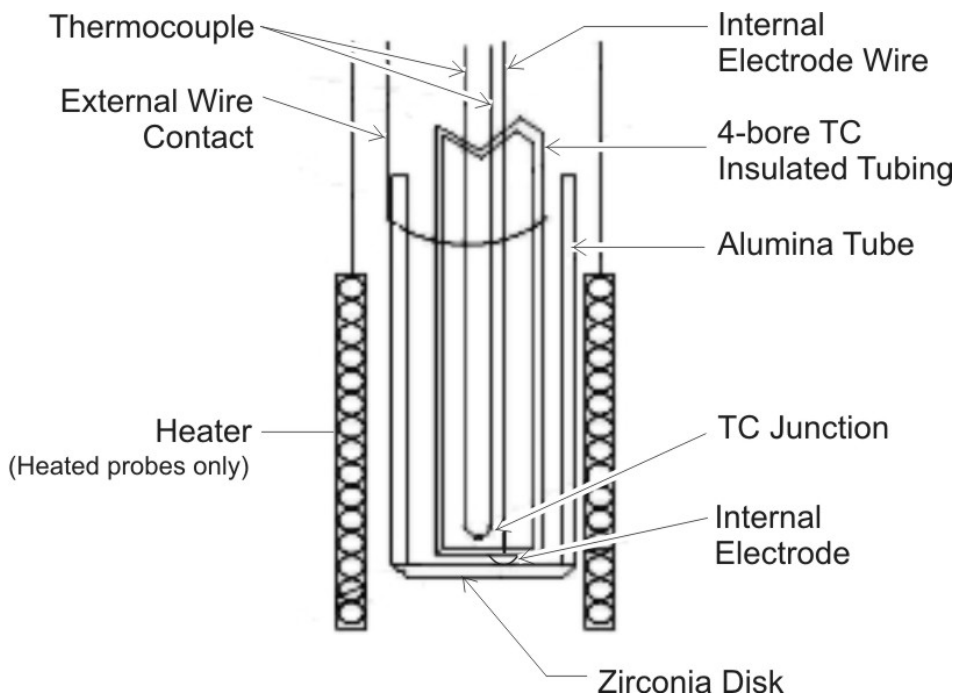

Figure 2-3: Internal Structure of the Zirconia Sensor and Probe

Heater control in the Model 9060L Oxygen Analyzer consists of a time proportioning temperature controller and solid state relay so that the thermocouple junction is controller to over 700°C (1300°F). Probes operating in a combustion environment above 650°C (1200°F) do not

require a heater. When the outside and inside of the sensor are exposed to different oxygen partial pressures, an EMF (E) is developed which obeys the Nernst equation:

$$E(\text{millivolts}) = \frac{RT}{4F} \log_e \left(\frac{(\text{PO}_2) \text{ Inside}}{(\text{PO}_2) \text{ Outside}} \right)$$

where T is the temperature (K) at the disc (>650°C (1200°F)), R is the gas constant. F is the Faraday constant and (PO₂) Inside and (PO₂) Outside are the oxygen partial pressures at the inner and outer electrodes respectively with the higher oxygen partial pressure being positive.

If dry air at atmospheric pressure, (21% oxygen) is used as a reference at the inner electrode, the following equations are obtained:

$$E(\text{millivolts}) = 2.154 \times 10^{-2} T \log_e \left(\frac{0.21}{(\text{PO}_2) \text{ Outside}} \right)$$

Transposing this equation:

$$(\%O_2) \text{ Outside (ATM)} = 0.21 \text{ EXP} \left(\frac{-46.421E}{T} \right)$$

The 9060L transmitter solves this equation which is valid above 650°C (1200°F). Either the probe heater or the process maintains the sensor temperature at this level.

2.2.3 Heater

CAUTION: DANGEROUS VOLTAGE (120 VAC) EXISTS WITHIN THE PROBE OR HEATER AND PRESENTS AN ELECTRICAL SHOCK HAZARD TO MAINTENANCE PERSONNEL. ALWAYS DISCONNECT THE PROBE FROM THE ANALYZER BEFORE WORKING WITH THE PROBE, SENSOR, OR HEATER.



THE EARTH CONNECTION (GREEN WIRE) FROM

THE PROBE/SENSOR MUST ALWAYS BE CONNECTED TO EARTH.

Power to the heater is supplied directly from the main power source, and the temperature is initially controlled above 700°C (1300°F) after power up.

2.3 Applications Not at Atmospheric Pressure

For high and low pressure applications where the pressure at the point of measurement is significantly above or below atmospheric pressure, compensation must be applied. The Model 9060L does not incorporate a pressure sensor thus no compensation is performed. This factor must be considered when reading concentration from the display under high or low pressure monitoring conditions.

2.4 Sensor Impedance

The zirconia sensor impedance is a basic measurement of the reliability of the oxygen reading. A probe or sensor with a high impedance reading will eventually produce erroneous signals. The analyzer checks the zirconia sensor impedance every 5 minutes and if the impedance is above the maximum level for a specific temperature then the impedance alarm will be activated. Typical sensor impedance is 1 K Ω to 8 K Ω at 720°C (1320°F).

2.5 Electronics

2.5.1 General

The signal processing uses an Intel[®] micro-controller with on-board RAM and ROM to control all signal processing, input/output, and display functions for the analyzer. System power can be either 120 or 220 VAC depending on the position of an internal switch.

The power supply circuitry and temperature controller circuitry are on the Power Supply PCB, which is mounted vertically, just behind the rear panel of the control unit.

The signal processing electronics including the sensor amplifier, micro-controller, analog to digital, and digital to analog converters are

located on the Main PCB, which is mounted vertically, just behind the front panel of the control unit.

2.5.2 Signal Processing

Figure 2-3 is a block diagram of the signal processing electronics described below.

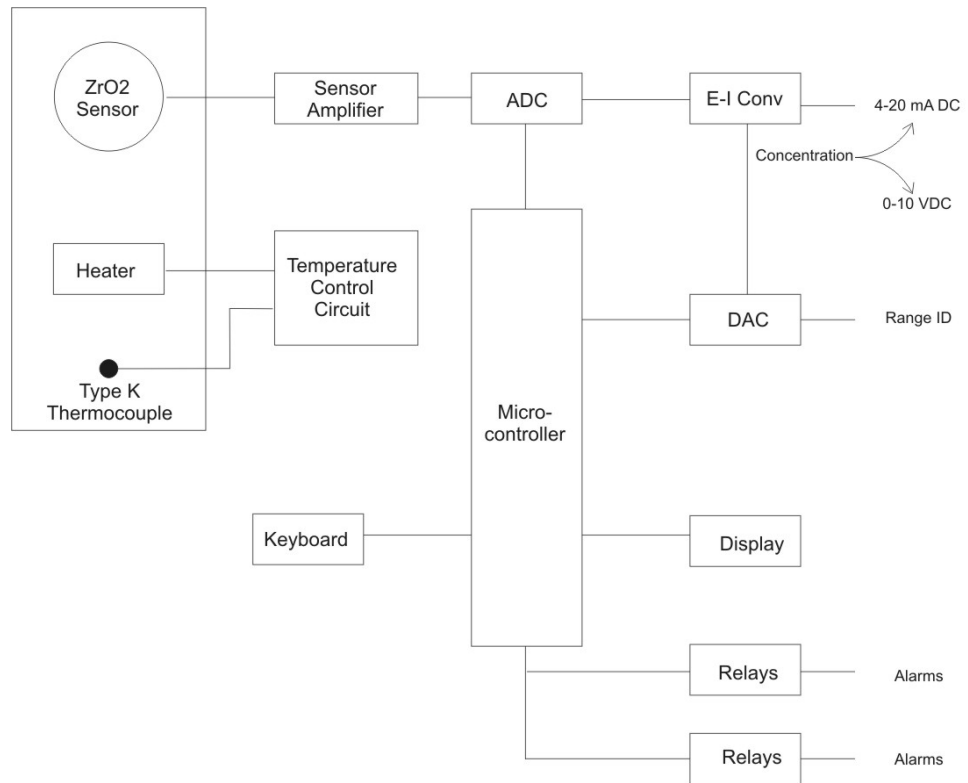

Figure 2-3: Signal Processing Block Diagram

In the presence of oxygen the sensor generates a millivolt potential which is fed to a voltage amplifier. The output from the sensor amplifier is sent to an analog to digital converter (ADC), and the resulting digital concentration signal is passed to the micro-controller. The ADC has a second channel which monitors the temperature of the probe.

The digital concentration signal along with input from the front panel buttons (KEYBOARD) is processed by the micro-controller, and appropriate output signals are directed to the display and alarm relays. The same digital information is also sent to a 12-bit digital to analog converter (DAC) that produces the 0-10 VDC analog concentration signal and the 0-10 VDC analog range ID output. A current to voltage converter (E-I CONV) produces the 4-20 mA DC analog concentration signal.

Installation

Installation of the analyzer includes:

1. Unpacking the system.
2. Mounting the control unit.
3. Installing the probe.
4. Making electrical connections.
5. Testing the installation.

CAUTION: READ THIS CHAPTER IN ITS ENTIRETY BEFORE INSTALLING THE SYSTEM.



FOR INDOOR USE ONLY.

3.1 Unpacking the Analyzer

As soon as you receive the instrument, carefully unpack and inspect the control unit, and any included accessories for damage. Immediately report any damage to the shipping agent. The analyzer is shipped with all the materials you need to install and prepare the system for operation.

3.2 Control Unit Installation

The 9060L control unit is designed to be panel mounted in a general purpose, indoor area, away from moisture and the elements. The unit should be installed at viewing level in a sheltered area.

Refer to the Outline Diagram D-77712 in the Appendix for the physical dimensions of the analyzer.

3.3 9060L Oxygen Probe Installation

To install the probe, weld a BSP or NPT socket to the flue in a suitable position for flue gas sensing. For the correct size of socket refer to probe specifications located in the Appendix.

Note: Mount the probe as close to the combustion source as possible. This reduces the lag time inherent in the sampling process and results in better control.

The probe has a typical response time of less than four seconds, so most of the delay time is associated with the transit time of the gas from the point of combustion to the point of sensing.

Probes can be mounted at any angle. When feasible, a vertical installation with the probe facing vertically downwards will eliminate the need for a filter. This is especially useful for processes with particulates in the flue gas. If a vertical mounting is not possible under these conditions, a filter may be necessary. This may require periodic filter replacement depending on the severity of the process.

If a flow guide tube is used (heated probes only), it is important that the fin points directly downstream. If the exact flow direction is not known, use a wind vane that can be made from a piece of wire and flat metal. If the flow guide tube is installed facing the wrong direction for any period, the suction filter may block with flue gas dust particles.

The maximum temperature for an unsupported flow guide tube is 750°C (1380°F). Above this temperature, provide a support and flanged flexible rubber joint as shown in Figure 3-1. The maximum temperature of a supported flow guide tube is 900°C (1650°F).

When installing a probe into a hot environment, slide the probe in slowly to avoid thermal shock to the internal ceramic parts. If the flue gas is 1000°C (1830°F), it should take approximately ten minutes to install a 500 mm (20”) probe, moving it in steps of about 20 mm (1”).

CAUTION: **IT IS IMPORTANT THAT THERE ARE NO AIR LEAKS UPSTREAM OF THE OXYGEN SENSING POINT, OTHERWISE THERE WILL BE A HIGH OXYGEN READING.**



If the probe is to be installed on a bend in the flue, it is best to locate it on the outer circumference of the bend to avoid dead pockets of flue gas flow. While the standard 9060L probe with a ‘U’ length of 250 mm (10”) will suit most low temperature flue applications, it is occasionally necessary to have a longer probe with the sensing tip in the center of the flue gas stream.

Although it is rare, occasionally a probe may sense oxygen vastly different from the average reading in the flue gas. If it occurs, move the

probe or install a longer probe. This is normally caused by stratification of the flue gas.

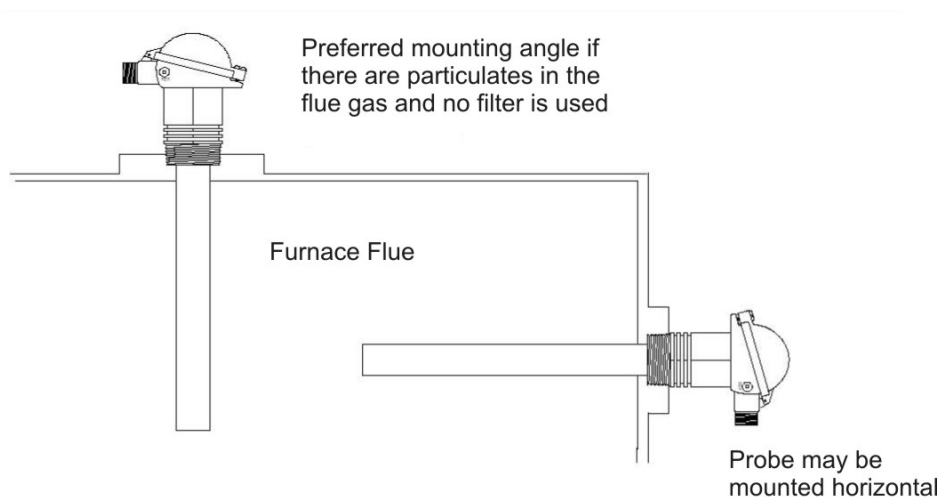

Figure 3-1: Oxygen Probe Mounting

3.4 Electrical Connections

Figure 3-1 shows the Model 9060L rear panel. For detailed pinouts, see the wiring/interconnection drawings in the Drawings section at the rear of this manual.

3.4.1 Primary Input Power

The power cord receptacle, fuse block and Power switch are located in the same assembly. A 6-foot, standard AC power cord is supplied with the control unit. Insert the female plug end of the power cord into the power cord receptacle.

The power supply allows direct connection to any 110 VAC, 50/60Hz power source. 220VAC is an optional configuration settable through an internal switch in the control unit. The fuse block, to the right of the power cord receptacle, accepts two 5x20mm IEC type T, 2 A, time-lag (T) fuse. (See *Fuse Replacement* in chapter 5, *Maintenance*.)

The Power switch is located on the right-hand end of the power source input receptacle assembly.

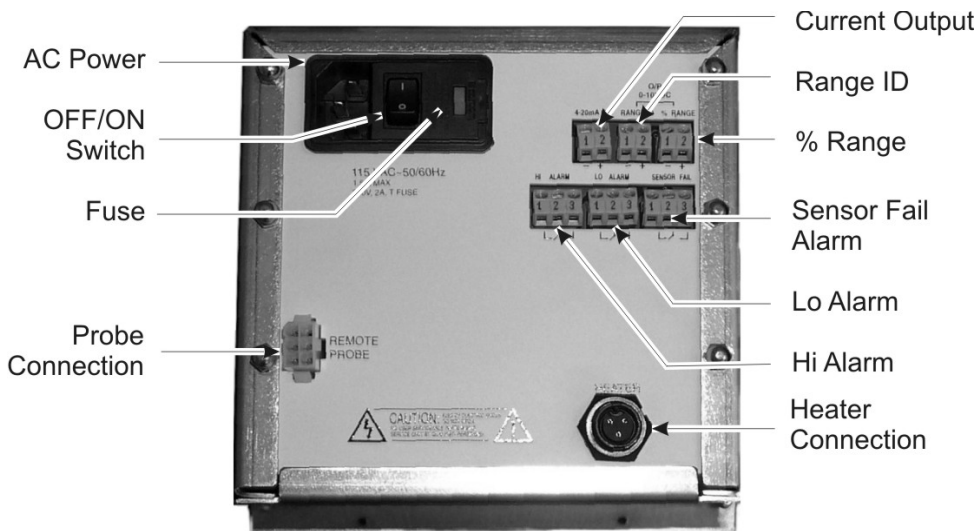

Figure 3-2: Model 9060L Rear panel

3.4.2 Analog Outputs

There are three DC output signal connectors with screw terminals on the panel. There are two wires per output with the polarity noted. See Figure 3-3. The outputs are:

- 0–10V % Range: Voltage rises with increasing oxygen concentration, from 0V at 0 percent oxygen to 10V at full scale percent oxygen. (Full scale = 100% of programmed range.)
- 0–10V Range ID: 03.33V = Low Range, 06.66V = High Range, 10V = Air Cal Range.
- 4–20 mA % Range: Current increases with increasing oxygen concentration, from 4 mA at 0 percent oxygen to 20 mA at full scale percent oxygen. (Full scale = 100% of programmed range.)

3.4.3 Alarm Relays

The three alarm-circuit connectors are screw terminals for making connections to internal alarm relay contacts. There is one set of contacts for each type of alarm. Contacts are Form C, with normally open and normally closed contact connections capable of switching up to 1.0 ampere at 125 VAC into a resistive load (2A for 30 VDC).

The alarm relay circuits are designed for failsafe operation, meaning the relays are energized during normal operation. If power fails the relays de-energize (alarms activated).

The contact connections are indicated diagrammatically on the rear panel as Normally Closed, Common, and Normally Open. Figure 3-3 explains how these act in failsafe operation.

Alarm 1 and Alarm 2 are configured as HI and LO respectively. A HI alarm will activate when concentration is above threshold, while a LO alarm will activate when concentration is below threshold.

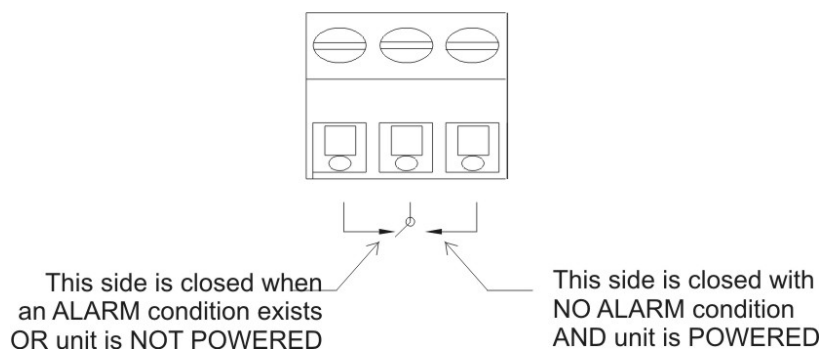

Figure 3-3: Contact ID for FAILSAFE Relay Operation

The specific descriptions for each type of alarm are as follows:

- | | |
|--------------------|---|
| Alarm #1 | Programmable as high alarm. Can be set anywhere between 0 and 100 % but no lower than Alarm #2. |
| Alarm #2 | Programmable as low alarm. Can be set anywhere from 0 to 100 % but no higher than Alarm #1. |
| Sensor Fail | Actuates when the output of the sensor falls below a factory programmed acceptable level or the thermocouple is open. |

CAUTION: THERE COULD BE HAZARDOUS VOLTAGE AT THE ALARMS TERMINALS, EVEN WHEN POWER IS REMOVED FROM THE INSTRUMENT.



3.4.1 Oxygen Probe Connections

The receptacle for the probe cable is located in the lower left-hand corner of the rear panel. The 6-pin polarized connector is keyed to fit only one way into the receptacle. Do not force it in. The other end of the cable connects to the probe assembly. See Figure 3-5. Connect the probe lead as shown in Figure 3-4 . The heater connector is on the right-hand corner of the rear panel. Six foot long cables are provided for the remote probe and the heater. Their Teledyne Analytical Instruments part numbers are listed on the spare parts list located in the appendix.

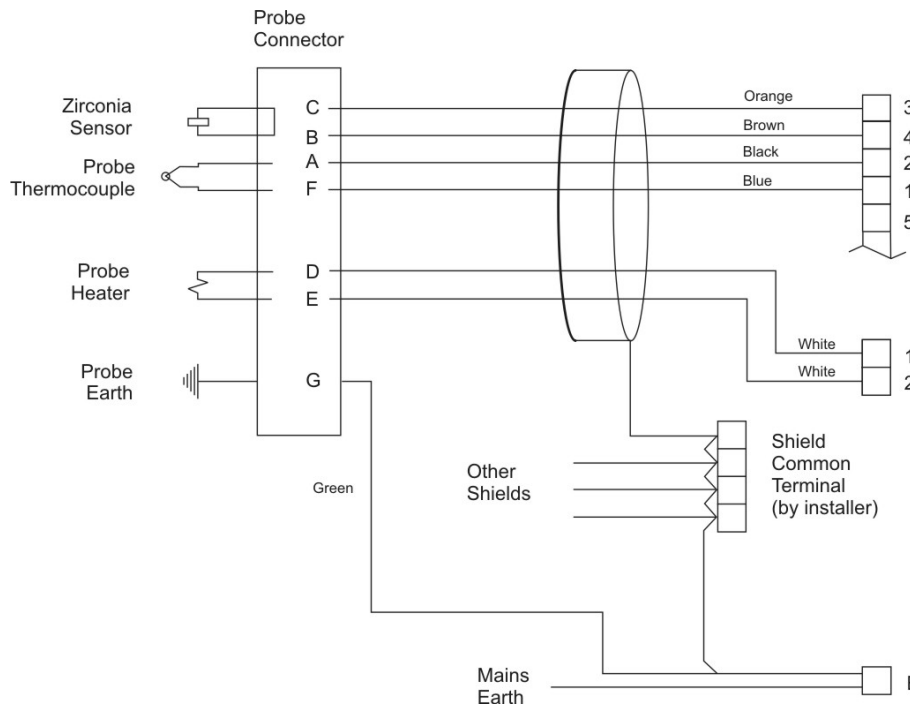

Figure 3-4: Model 9060L Heated Probe Cable Connection



Figure 3-5: Connections to Probe

3.5 Installation Checklist

Prior to powering up the unit make sure you have:

- Installed the unit correctly
- Checked the probe and welded probe socket for leaks

Once the above checks have been made, you can connect the power source. Wait approximately 30 minutes for warm up, two hours wait is best. After that, the instrument is ready for operation.

Operation

4.1 Introduction

Once the analyzer has been mounted, the probe installed, and the electrical connections made, the analyzer can be configured for your application. This involves setting the system parameters:

- Defining the user selectable analysis ranges.
- Setting alarm setpoints.
- Calibrating the instrument.

All of these functions are performed via the front panel controls, shown in Figure 4-1.

Analyzing for the percent oxygen level in the gas passing through the probe and sensor is the default mode of operation. As long as no front panel buttons are being pressed the analyzer is analyzing.

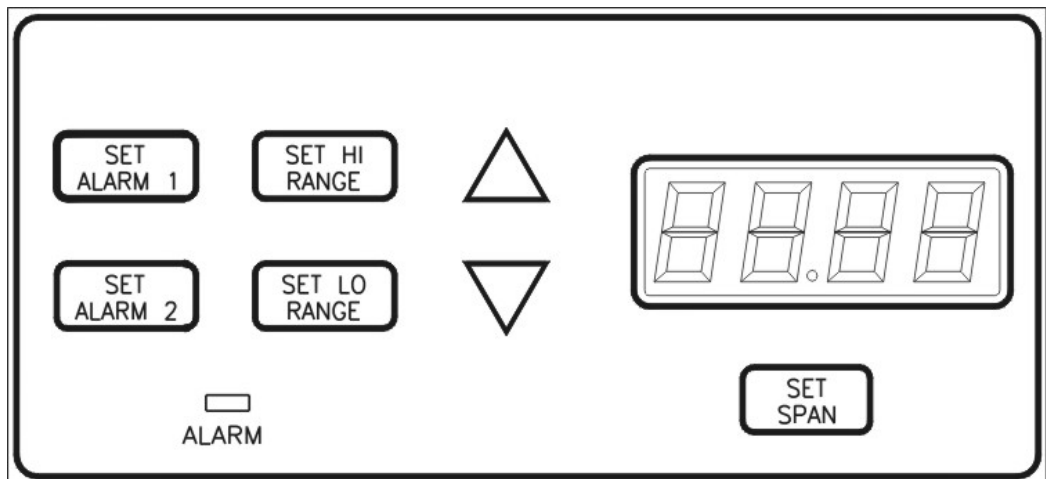

Figure 4-1: Front Panel Controls and Indicators

4.2 Using the Function and Data Entry Buttons

When no buttons on the analyzer are being pressed, the instrument is in the analyze mode. It is monitoring the percent of oxygen in the sample gas that is flowing through the remote probe.

When one of the function buttons is being pressed, the analyzer enters the setup mode or the calibration mode.

Setup Function Buttons:

There are 4 setup function buttons on the analyzer:

- SET ALARM 1
- SET ALARM 2
- SET HI RANGE
- SET LO RANGE

Calibration Button:

The calibration mode button is:

- SPAN

Data Entry buttons:

The data entry buttons (Δ and ∇) increment the values displayed on the PERCENT OXYGEN meter while one of the function buttons is being held down.

- Δ : Increments the displayed value upwards.
- ∇ : Increments the displayed value downwards.

Any of the functions can be selected at any time by holding down the appropriate button.

Each function will be described in the following sections. Although the operator can use any function at any time, the order chosen in this manual is appropriate for an initial setup.

4.3 Setting the Analysis Ranges

The two user definable analysis ranges are both capable of being adjusted for from 0-1 to 0-100% oxygen concentration. Whatever values are selected, the analyzer automatically switches from the LO range to the HI range when the oxygen concentration reaches 100% of the LO

range full scale value, and it switches back to the LO range when the oxygen concentration reaches 85% of the LO range full scale value

Note: The HI Range setpoint MUST be set at a higher concentration percentage than the LO Range setpoint.

4.3.1 HI Range

Setting the HI Range full scale value defines the LEAST sensitive analysis range to be used. To set the HI Range:

1. Press the SET HI RANGE function button once.
2. Immediately (within 5 seconds) press either the Δ or ∇ button to raise or lower the displayed value, as required, until the display reads the desired full scale percent concentration.

4.3.2 LO Range

Setting the LO Range full scale value defines the MOST sensitive range to be used. To set the LO Range:

1. Press the SET LO RANGE function button once.
2. Immediately (within 5 seconds) press either the Δ or ∇ button to raise or lower the displayed value, as required, until the display reads the desired full scale percent concentration.

4.4 Setting the Alarm Setpoints

The alarm setpoints can be adjusted over the full range of the analyzer (0-100% oxygen content). They are set as a percent of oxygen content, so that an alarm set to indicate 9.6 on the display will activate at 9.6% O₂ on any O₂ range.

4.4.1 Set Alarm 1 (HI alarm)

Alarm 1 is preset as a high alarm. To configure this alarm to your preferences:

1. Press the SET ALARM 1 function button once.
2. To change the setting at which the alarm will be actuated, press the SET ALARM 1 function button once more. The alarm setpoint will flash on the LED display. Press either the Up or Down keys to raise or lower the displayed value, as required,

until the display reads the desired percent concentration. If within 5 seconds no key is pressed, the instrument will return to the sample mode and display oxygen concentration.

After setting the value wait for the unit to time out of this mode (approximately 5 seconds) and return to displaying oxygen concentration.

4.4.2 Set Alarm 2 (LO alarm)

Alarm 2 is preset as a low alarm. To configure this alarm to your preferences:

1. Press the SET ALARM 2 function button once.
2. To change the setting at which the alarm will be actuated, press the SET ALARM 2 function button once more. The alarm setpoint will flash on the LED display. Press either the Up or Down keys to raise or lower the displayed value, as required, until the display reads the desired percent concentration. If within 5 seconds no key is pressed, the instrument will return to the sample mode and display oxygen concentration.

After setting the value wait for the unit to time out of this mode (approximately 5 seconds) and return to displaying oxygen concentration.

4.4.3 Sensor Fail Alarm

The SENSOR FAIL alarm is factory set to a reading less than 0.05% O₂. Should this alarm trigger, the ALARM indicator below the SET function buttons will blink, and the alarm relay contact dedicated to this function will change state.

The SENSOR FAIL alarm will also activate when the temperature is below 650°C, or the thermocouple is sensed as open.

4.5 Selecting a Fixed Range or Autoranging

The Model 9060L can operate in fixed high, fixed low, or autoranging mode. To change modes:

1. Press and then release the SET HI RANGE and the SET LO RANGE buttons simultaneously.



2. Immediately (within 5 seconds) press either the Δ or ∇ button until Auto, Lo, or Hi displays on the LCD, as desired.

After about three seconds, the analyzer resumes monitoring in the selected range mode.

4.6 Oxygen Calibration

There are two types of calibration one is air calibration, and the other is span which uses some other gas other than air. Since the zirconia sensor uses air as reference, the output is nearly zero millivolts. So, in doing the air calibration, you are basically reading the offset of the sensor. The span calibration (using gas other than air) would make the sensor give an output other than zero, thus it is the high calibration.

4.6.1 Span Calibration

Connect a suitable span gas to the port on the side of the probe head. To do this, remove the plug on the gland on the side of the probe marked REF. See Figure 4.2 Attach the span gas at this port using a suitable fitting and use a flow rate between 1-5 liters per minute. The span gas exits at the tip of the probe. A suitable span gas can be an oxygen mixture between 1 to 16 %, with the balance being nitrogen. Using a concentration between 1 to 5% is preferable, as the sensor will yield a higher output.

Power up the instrument and allow the LED reading to stabilize. Set the alarm setpoints and the full scale ranges to the desired values.



Figure 4-2: Calibration Port on Probe Head

Span Procedure:

1. Press the SPAN button once.

Note: The numeric LED starts flashing and will continue to flash

for five minutes before timing-out. During this five minute interval, the LED will continue to track gas through the analyzer.

2. Flow span gas of a known oxygen concentration (between 1 and 16% oxygen) into the analyzer. The analyzer will begin to track the span gas.

Note: The alarms will not change state during span calibration.

3. When the meter stabilizes, use the UP/DOWN arrows to adjust the analyzer span value to the exact percent O₂ concentration in the span gas. Remember that the acceptable range is 1 to 16% of adjustment. The display will freeze at 1% or 16% if you try to adjust beyond those limits.

Note: When an arrow button is first pressed, the LED begins flashing slightly more rapidly and no longer tracks the span gas. Instead, it responds to the UP/DOWN keystrokes.

Note: While the LED is flashing slightly more rapidly, the SPAN routine will time-out in five seconds (instead of five minutes), if no further keystrokes are entered.

4. When the span value is set to the known concentration of O₂ in the span gas, stop pressing the keys and wait for five seconds.

Note: When you stop pressing the UP/DOWN keys, the rapid flashing will cease and the analyzer will acquire the new span value after five seconds.

The alarms will only be non-responsive for 60 seconds. This time frame allows you to reintroduce sample gas into the analyzer.

5. Shut off the span gas flow and immediately flow sample into the analyzer.
6. After a few minutes, disconnect the calibration gas line and replace the plug to cap off the calibration port.



4.6.2 Air Calibration

To perform air calibration, make sure you have air flowing through the same inlet you use for span calibration at a flow of 1- 5 liters per minute. Wait for readings to stabilize.

Press both the SET ALARM 1 and SET ALARM 2 simultaneously. The LED display will show “**OFSt**” for a few seconds. After that the instrument should read near 20.9%.

The sensor output is expected to be near zero millivolts, if the offset of the sensor is too high, the analyzer will not calibrate.

4.7 Supplementary Information

If, during the span procedure, you pressed the SPAN button by mistake, you must wait five minutes for the analyzer to resume analysis or you can press the UP button and then the DOWN button. (Pressing the UP and DOWN buttons causes the analyzer to time-out in five seconds instead of five minutes).

If during the span procedure, you press the RANGE or ALARM buttons:

- either the range or alarm routine will be activated.
- any changes to span will be rejected.
- the 60 second alarm delay will not occur, i.e., the alarms will be responsive immediately.

CAUTION:  **TI/AI CONSIDERS THE ACTION OF PRESSING THE ALARM OR RANGE BUTTONS TO BE AT YOUR (THE USER'S) DISCRETION AND NOT UNDER GUARANTEE OF ALARM PROTECTION.**

4.8 Probe Temperature

The probe temperature can be displayed momentarily and adjusted if needed. While the instrument is in normal mode, displaying oxygen concentration, press the UP and DOWN arrow keys simultaneously. The red LED display will show the probe temperature in degrees centigrade for five seconds.

Within the time the temperature is being displayed, one can use the UP and DOWN arrow keys to adjust the temperature, thus recalibrating the temperature readout.

WARNING: **TEMPERATURE READING IS CALIBRATED AT THE FACTORY. DO NOT ATTEMPT RECALIBRATION OF THE PROBE TEMPERATURE. ERROR OF A FEW DEGREES WOULD HAVE LITTLE IMPACT ON THE OXYGEN CALCULATIONS, BUT IF THE PROBE IS GROSSLY MISCALIBRATED IT WILL HAVE AN ADVERSE EFFECT ON THE OXYGEN READOUT. ONLY QUALIFIED PERSONNEL SHOULD RE-CALIBRATE TEMPERATURE.**



4.8.1 Low Temperature

For the zirconia sensor to operate properly the temperature of the probe must be above 650 degrees Centigrade. While the temperature is below this threshold, the red LED alternates showing “t-Lo” and the oxygen concentration.

4.8.2 Open Thermocouple

The electronics checks if the thermocouple (TC) is open. If it detects that the TC is open the Sensor failure contacts will go into alarming position. Red LED display may alternate between oxygen concentration and the error code “-02-”. Refer to Section 4.9 for information on Error Codes.

4.9 Error Messages

The instrument will display an error code when it detects a malfunction or error condition. The possible codes and common causes are listed below:

- 01-** This message indicates that there is possible failure on the Analog to Digital Converter, ADC. This may happen when the micro-controller cannot communicate with the ADC. In this state, the oxygen reading is unreliable.

- 02-** This message is displayed when the input voltage to the ADC rises above the upper limit of the ADC. This could occur if the probe is exposed to zero oxygen concentration, making the

output of the sensor higher than the top scale of the ADC. It may also occur if the thermocouple should open.

- 03-** This message is displayed when the input voltage to the ADC has fallen below the lower negative limit of the ADC.

Maintenance

Aside from normal cleaning and checking for leaks at the probe connection, the Model 9060L should not require any maintenance beyond replacement of a blown fuse. Routine maintenance includes occasional recalibration, as described in Chapter 4, *Operation*.

5.1 Replacing the Fuse

CAUTION: REMOVE POWER TO UNIT BEFORE REPLACING THE FUSE.



When a fuse blows, check first to determine the cause, then replace the fuse using the following procedure:

1. Disconnect the AC power and place the power switch located on the rear panel in the **O** position. Remove the power cord from the receptacle.
2. The fuse receptacle is located in the power cord receptacle assembly in the upper left-hand corner of the rear panel. See Figure 5-1.

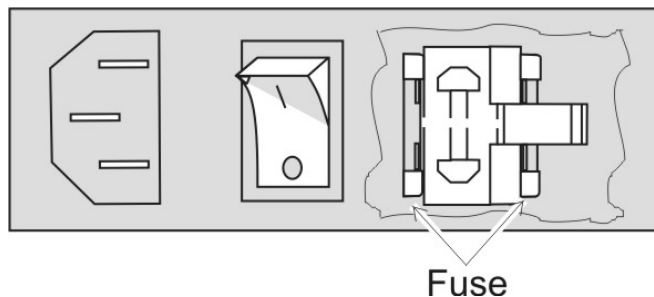

Figure 5-1: AC Fuse Replacement

3. Insert a small flat-blade screwdriver into the slot in the receptacle wall nearest the fuse and gently pry open the fuse receptacle. The fuse holder will slide out. There are two fuses in use and are visible in the clip.
4. Remove the bad fuse and replace it with a 5x20mm 2A, 250 VAC, IEC time lag (T) fuse (P /N F1296).
5. Replace the fuse holder into its receptacle, pushing in firmly until it clicks.

Appendix

A.1 Specifications

Ranges: 0-3 % and 0-10 % oxygen (Standard Ranges), and 0-25 % (nominal) Calibration Range. User selectable % Ranges can be set between 1% and 100 % oxygen .

Signal Output: Voltage: 0–10 VDC, negative ground
Current: 4-20 mA, negative ground

Range ID: 0-10 VDC.

Display: Light emitting diode display.

Alarms: Two customer selectable fully adjustable HI and LO alarms.

One sensor failure alarm.

Alarm relays form "C" contacts, dry contacts rated at 2A for 30VDC, 1A for 115VAC.

System Operating Temp: 0-50 °C

Accuracy: ±2% of full scale at constant temperature
±5% of full scale through operating temp. range once temp. equilibrium is reached. (At 3 % and higher user defined ranges.)

Response Time: 90% in less than 4 seconds at 25 °C.

System Power Requirements: 120 VAC, 50/60Hz (optional 220VAC), 110W.

System Enclosure: Panel mount. Dimensions (Approx.) 7.0 W x 6.75 H x 4.26 D.

Sensor Type: Zirconia, solid state

A.2 Probe Specifications

Application: Combustion flue below 700°C (1290°F),
above 700°C (1290°F) 900°C (1650°F) — no
contaminants.

With contaminants see notes 1 &2

Temperature Range: 0-900°C 800-1400°C 800-1200°C
(32-1650°F) (1470-2550°F) (1470-2190°F)

Length: 250-1000 mm 500-1160 mm 457-1219 mm
(10" to 40") (20" to 46") (18" to 48")

Process Connection: 1 1/2" BSP 3/4" BSP 1" BSP or equivalent
NPT

Electrical Connection: Weatherproof plug-in connector or
optional screw terminals. Plug connector
supplied with the cable. Ex d heads have
screw terminals.

Cable: Order a specific length with the analyzer
except for hazardous installations where
the cable is supplied by the customer.

Heater: Yes

Flue Gas Thermocouple: K

Response Time: Typically < 4 secs.

Head Temperature: 125°C (250°F)

Reference Gas: Ambient air 50 to 500 cc/min (6 to 60
scfm). Pump supplied with analyzer

Ref Air Connection: 1/4" NPT integral air line in probe cable.
Barbed fitting to 3/16" ID PVC tube.

Filter: Removable sintered stainless steel
particulate filter, 15 micron.

Calibration Gas Connection: 1/8" NPT female 1/8" NPT female 1/8"
NPT female

Weight : 0.6 kg (1.32 lbs.)

Notes:

1. Care must be taken to avoid contact with explosive or inflammable gases with 9060L heated probes when hot.
2. Please contact factory for corrosives other than sulphur or zinc. We can provide test materials to try in your atmosphere.

A.3 Spare Parts List

QTY.	P/N	DESCRIPTION
1	B-76751A	PC Board, Main
1	B-76513A	PC Board, Power Supply
2	F-1296	Fuse (AC), 2A, 250VAC, IEC Type T, 5x20mm
1	---	Oxygen Probe (call TI/AI to specify U Length)
1	B77926A	Cable Assembly, Probe Heater
1	B77926B	Cable Assembly, Remote Probe

Note :Orders for replacement parts should include the part number and the model and serial number of the system for which the parts are intended.

Send orders to:

TELEDYNE INSTRUMENTS***Analytical Instruments***

16830 Chestnut Street
City of Industry, CA 91749-1580

Telephone: (626) 934-1500

Fax: (626) 961-2538

Web: www.teledyne-ai.com
or your local representative.

Email: ask_tai@teledyne.com

A.4 Reference Drawing

D-77712	Outline Diagram
D77713	Control Unit Final Assembly
C77925	Interconnection Diagram

A.5 Probe or Sensor EMF Tables

ZIRCONIA OXYGEN SENSOR OUTPUT (mV) PROBE TYPE 9060L, SENSOR TYPE 9060LEX

% OXYGEN	mV at 720°C (1320°F)
21.0	0.00
20.5	0.46
20.0	0.99
19.5	1.53
19.0	2.09
18.5	2.66
18.0	3.25
17.5	3.85
17.0	4.47
16.5	5.11
16.0	5.77
15.5	6.45
15.0	7.15
14.5	7.87
14.0	8.62
13.5	9.40
13.0	10.21
12.5	11.05
12.0	11.92
11.5	12.83

11.0	13.78
10.5	14.78
10.0	15.82
9.5	16.92
9.0	18.08
8.5	19.30
8.0	20.60
7.5	21.98
7.0	23.45
6.5	25.04
6.0	26.75
5.5	28.61
5.0	30.65
4.5	32.90
4.0	35.42
3.5	38.28
3.0	41.58
2.5	45.48
2.0	50.25
1.5	56.41
1.0	65.08
0.5	79.91
0.2	99.51

'K' TC mV 29.212 at 720 °C (1320°F)

These tables are based on the Nernst equation:

Sensor e.m.f. = $0.02154 \times T \times \ln (20.95 / \% \text{ oxygen})$,

where $T = ^\circ \text{K} (^\circ \text{C} + 273)$, e.m.f. is in mV's

Index

- accuracy, 43
- address, 45
- air calibration, 35, 37
- air purge, 16
- alarm delay, 36
- alarm, 43
 - concentration, 12
 - HI, 27
 - LO, 27
 - sensor fail, 27, 34
 - sensor failure, 12
 - setpoint, 33
 - threshold, 12, 27
- Alarm 1, 27
- Alarm 2, 27
- alarm connection, 26
- alarm connections, 14
- alarm delay, 37
- alarm indicator, 12
- alarm relay circuit, 27
- alarm setpoint, 13
- analog concentration signal, 22
- analog to digital converter, 20, 21, 38
- analysis range, 32
- analyze mode, 32
- applications, 11
- autoranging, 11
- block diagram, 21
- BSP socket, 23
- cable, 44
- calibration, 35
- calibration check, 16
- calibration mode, 32
- calibration mode keys, 32
- calibration range, 11
- caution sign, iv
- CMOS, 11
- combustible gas warning, x
- concentration output. *See* output
- contact ID, 27
- contaminants, 15
- control unit, 15, 16
- copyright, ii
- current to voltage converter, 22
- data entry keys, 13, 32
- default mode, 31
- digital concentration signal, 22
- digital meter. *See* display
- digital to analog converter, 20, 22
- dimensions, 43
- display, 11, 13, 43
- display control, 20
- display, frozen, 36
- Down Arrow, 13
- E-I converter, 22
- EMF table, 46
- error code, 38
- failsafe, 27
- features, 11
- figures listing, viii
- filter, 17, 24, 44
- flow guide tube. *See* guide tube
- flow rate, 37
- flow rate, span gas, 35
- flue velocity, 17
- form "C" contacts, 43
- Form C relay contacts, 26
- front panel, 12, 31
- function keys, 12
- fuse, 25, 42
- fuse block, 25
- fuse replacement, 41
- gas connection, 44
- general purpose area, 23
- guide tube, 17, 24
- heated probe, 16
- heater, 19
- heater control, 18
- heater power, 20
- HI range, 32
- impedance, 20
- impedance alarm, 20
- increment the display, 32
- initial setup, 32

- input connector, 13
- insertion length, 17
- installation checklist, 29
- instrument range, 11
- internal power switch, 20, 25
- lagging extension, 17
- leak check, 29
- LED, 13
- LED flashing, 35
- LO range, 33
- main PCB, 21
- maintenance, 41
- manuals, additional, v
- Measurement Parameters Readout, 13
- membrane switches, 12
- Meter Readout, 13
- micro-controller, 15, 20, 21
- millivolt potential, 21
- mounting thread, 17
- Nernst equation, 19, 47
- NPT socket, 23
- OFSt, 37
- open thermocouple, 27, 34, 38
- operating temperature, 43
- operation, 31
- output, 15, 43
 - analog, 12, 14
 - current, 26
 - range ID, 26
 - voltage, 26
- output connector, 13
- oxygen partial pressure, 19
- oxygen reading reliability, 20
- oxygen reading unreliable, 38
- panel mount, 23
- parts list, 45
- power, 20
- power connection, 14
- power cord, 25
- power cord receptacle, 25, 41
- power requirements, 43
- power supply PCB, 20
- power switch, 14, 25
- pressure, 18
- pressure compensation, 20
- probe, 15, 16, 18, 20
- probe cable connection, 28
- probe configuration, 17
- probe installation, 23
- probe length, 17, 44
- probe mounting angle, 24
- probe options, 17
- probe temperature, 13, 21, 37
- process pressure. *See* pressure
- pump, 18, 44
- RAM, 11, 20
- range, 13, 43
- range ID, 22, 43
- range identification, 12
- range switch-over point, 33
- rear panel, 13, 14, 25
- REF, 35
- reference air, 16
- reference air pump, 18
- reference gas, 44
- relay, 18, 22, 43
- relay contacts, 26
- response time, 15, 24, 43, 44
- ROM, 11, 20
- safety information, iv
- sampling line, 18
- sensor, 11, 15, 16, 18, 20
- sensor amplifier, 20, 21
- sensor connector, 14
- sensor offset, 35
- sensor temperature, 19
- serial number, iii
- Set Alarm 1, 12
- SET ALARM 1, 32, 33
- Set Alarm 2, 13
- SET ALARM 2, 32, 34
- Set HI Range, 13
- SET HI RANGE, 32, 33
- Set LO Range, 13
- SET LO RANGE, 32, 33
- setup function keys, 32
- setup mode, 32
- sheath, 16
- signal processing, 15, 20
- solenoid, 16
- solid electrolyte, 18
- Span, 13
- SPAN, 32, 35
- span calibration. *See* calibration
- span calibration point, 13
- span gas, 35
- span gas concentration, 35
- span value acquisition time, 36
- stratification, 25
- system parameters, 31

- tables listing, ix
- technician symbol, iv
- temperature, 44
- temperature controller, 18
- temperature maximum, 24
- temperature too low, 38
- thermal shock, 15, 24
- thermocouple, 18
- thermocouple type, 44
- time out, 34
- time-out, 37
- t-Lo, 38
- transit time, 24
- U length, 24
- Up Arrow, 13
- voltage amplifier, 21
- warning sign, iv
- warranty, ii
- water vapor, 16
- website address, v
- zero oxygen concentration, 38
- zirconia element, 18
- zirconia sensor. *See* sensor

NOTES: UNLESS OTHERWISE SPECIFIED.

1. ALL DIMENSIONS ARE IN INCHES (± 0.06) AND MILLIMETERS ($\pm 1.$), INCHES[mm]

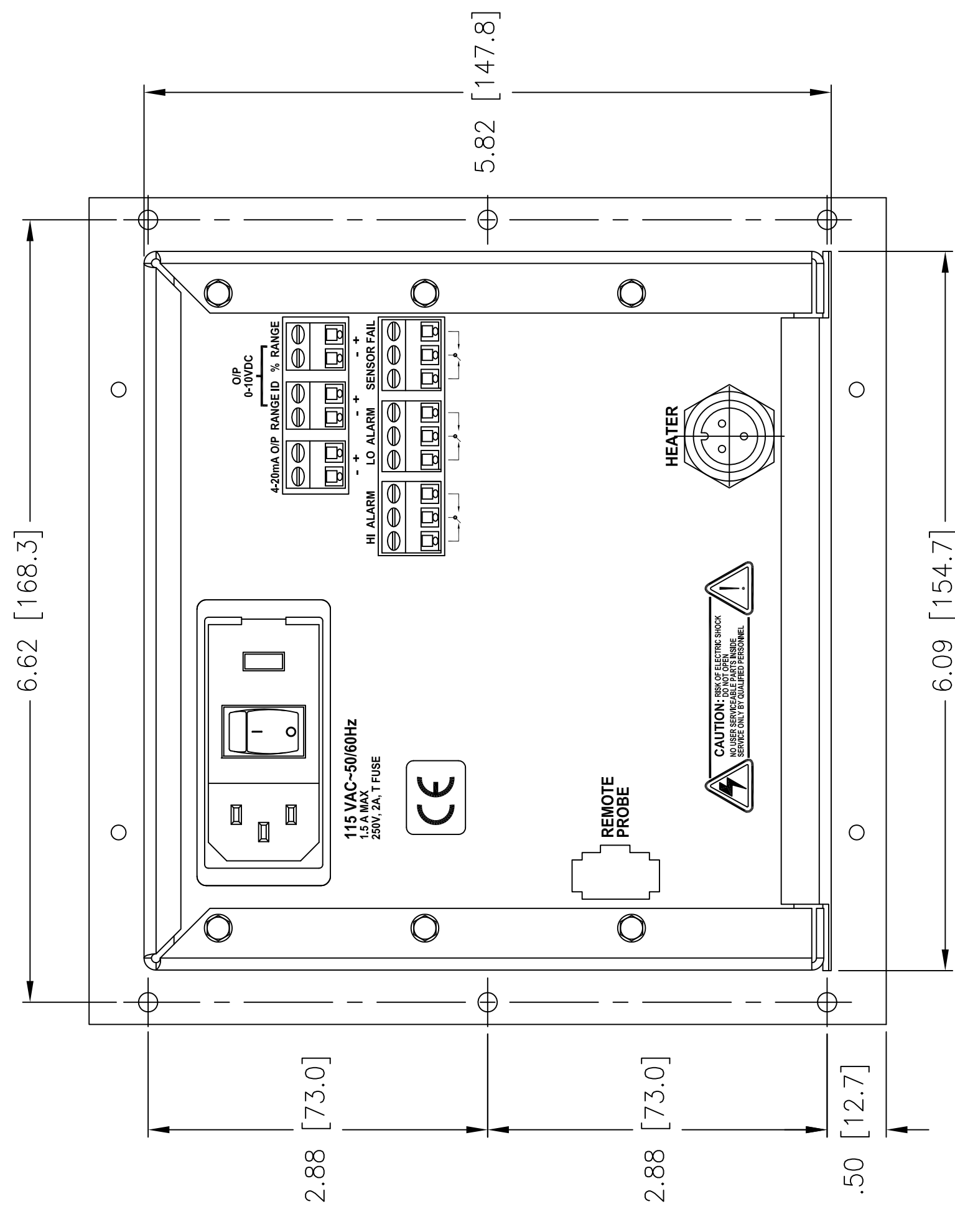
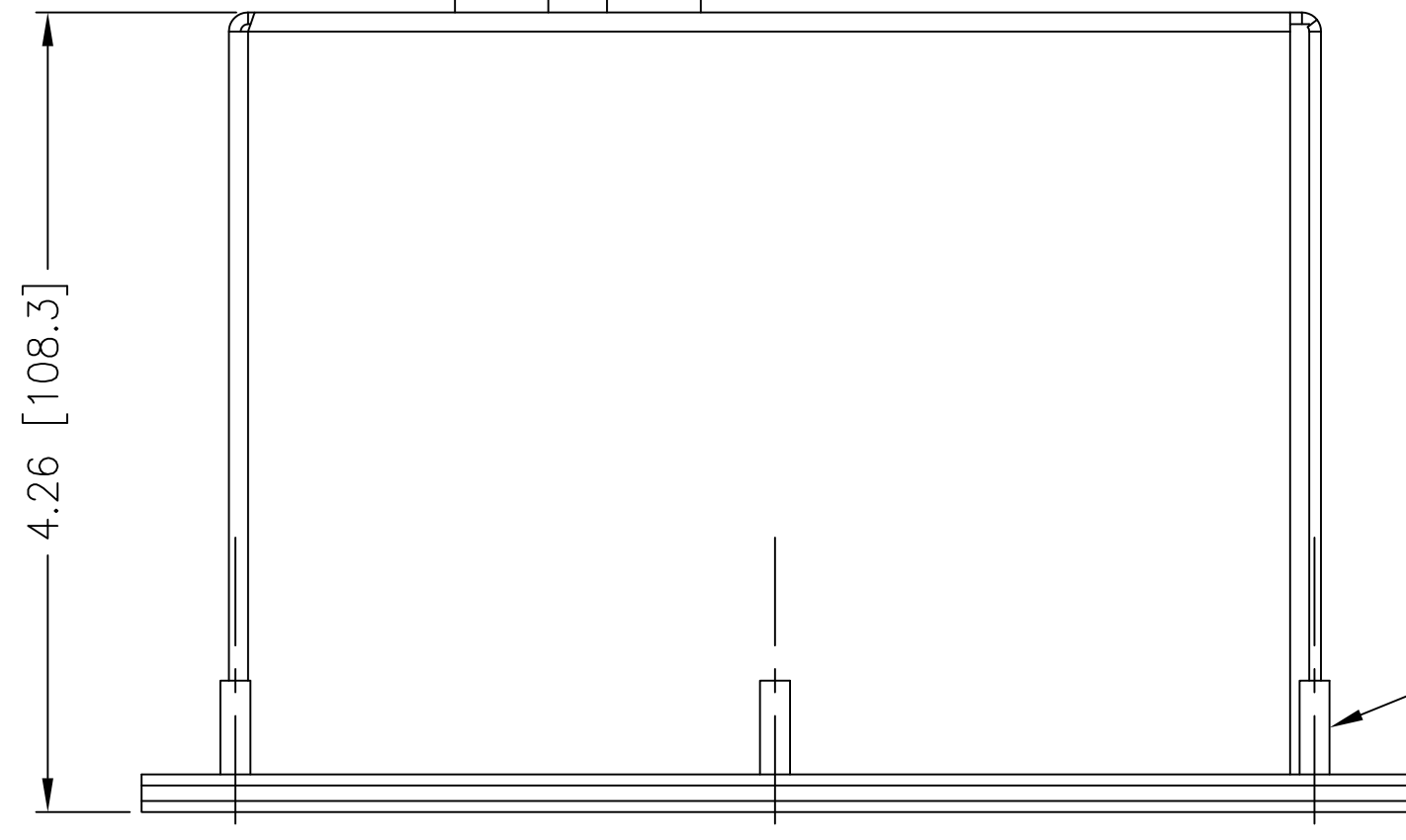
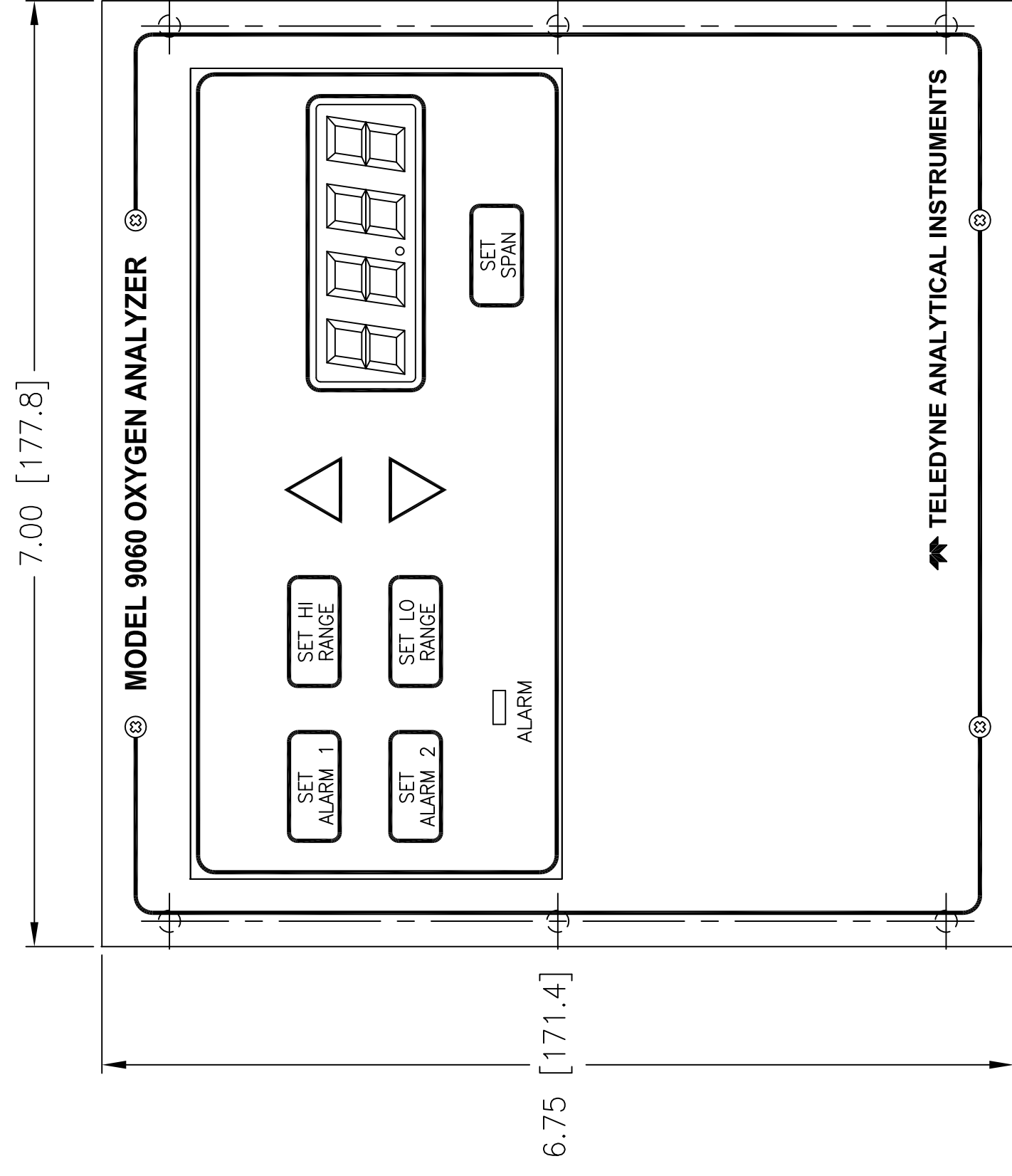

REV	DESCRIPTION	DATE	APP.	REV.
0	INITIAL RELEASE	04/04/05	TJC	--
1	MODEL NO WAS Z IS L	07/21/05	JCR	JCR

DO NOT SCALE DWG		TOLERANCE UNLESS OTHERWISE SPECIFIED: ANGULAR $\pm 1/2^\circ$	
LINEAR $\pm .XX$		ANGULAR $\pm .02$	
LXXX = ± 0.10		LXXX = ± 0.10	

SIGNATURES	DATE	TITLE
DRET: JOHN REYES	03/30/05	TELEDYNE INSTRUMENTS Analytical Instruments A Teledyne Technologies Company City of Industry, California, 91746, USA
CHK:		
APPR:		
ENGR:	ANGEL ALEGRIA	
F/ D-77713	C.O.: 072591	
REFERENCE	CAD ID: D77712-1	

SCALE	1:1
SIM	NONE
SHEET	1 OF 1
REV	1

DWG NO.	D-77712
NONE	

THE DRAWING IS THE PROPERTY OF TELEDYNE ANALYTICAL INSTRUMENTS AND CONTAINS CONFIDENTIAL INFORMATION. IT IS NOT TO BE COPIED, REPRODUCED OR USED WITHOUT WRITTEN PERMISSION.	
TELEDYNE INSTRUMENTS Analytical Instruments A Teledyne Technologies Company City of Industry, California, 91746, USA	
OUTLINE DIAGRAM CONTROL UNIT MODEL 9060L	

NOTES: UNLESS OTHERWISE SPECIFIED.

* USE 22 GAUGE MINIMUM WIRING FOR INTERCONNECTION DIAGRAM.
SEE SHEET 2 OF 2 FOR WIRING OF ALTERNATE 7 CONDUCTOR CABLE.

OXYGEN PROBE
(TOP VIEW)

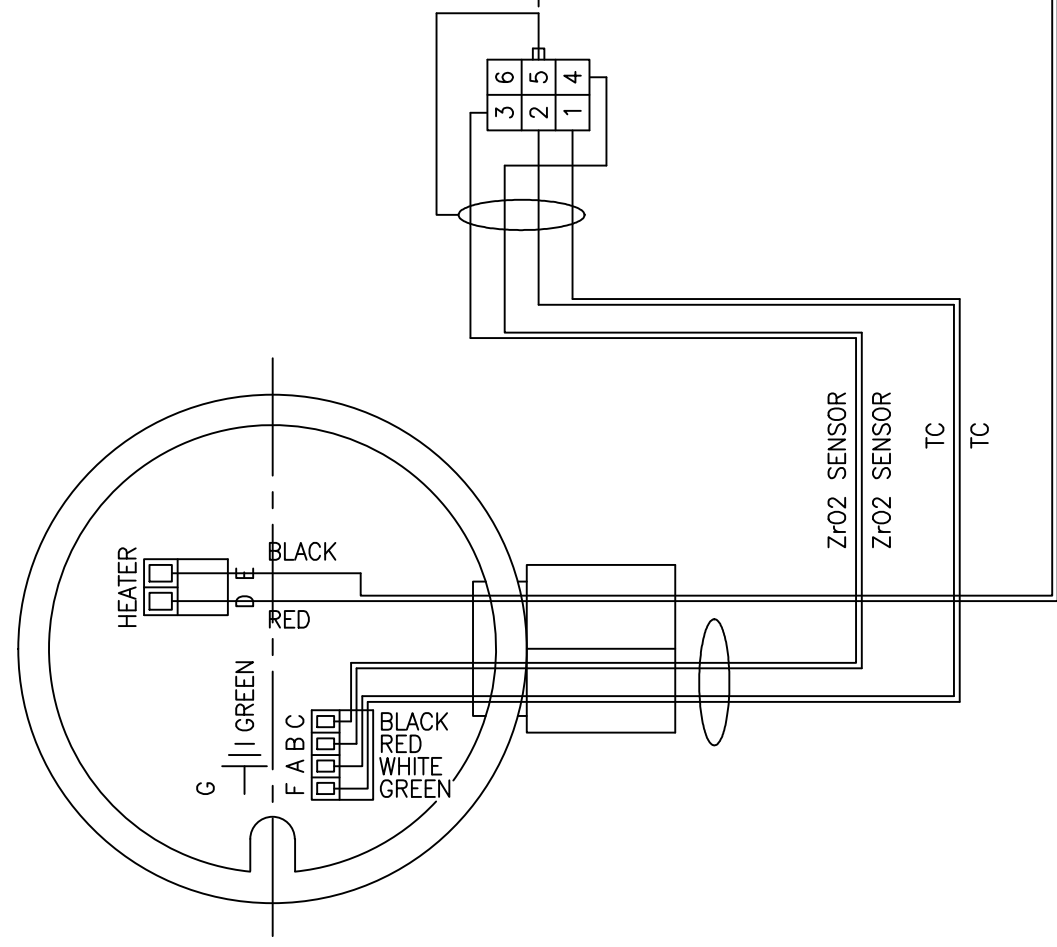

CONTROL UNIT
(REAR VIEW)

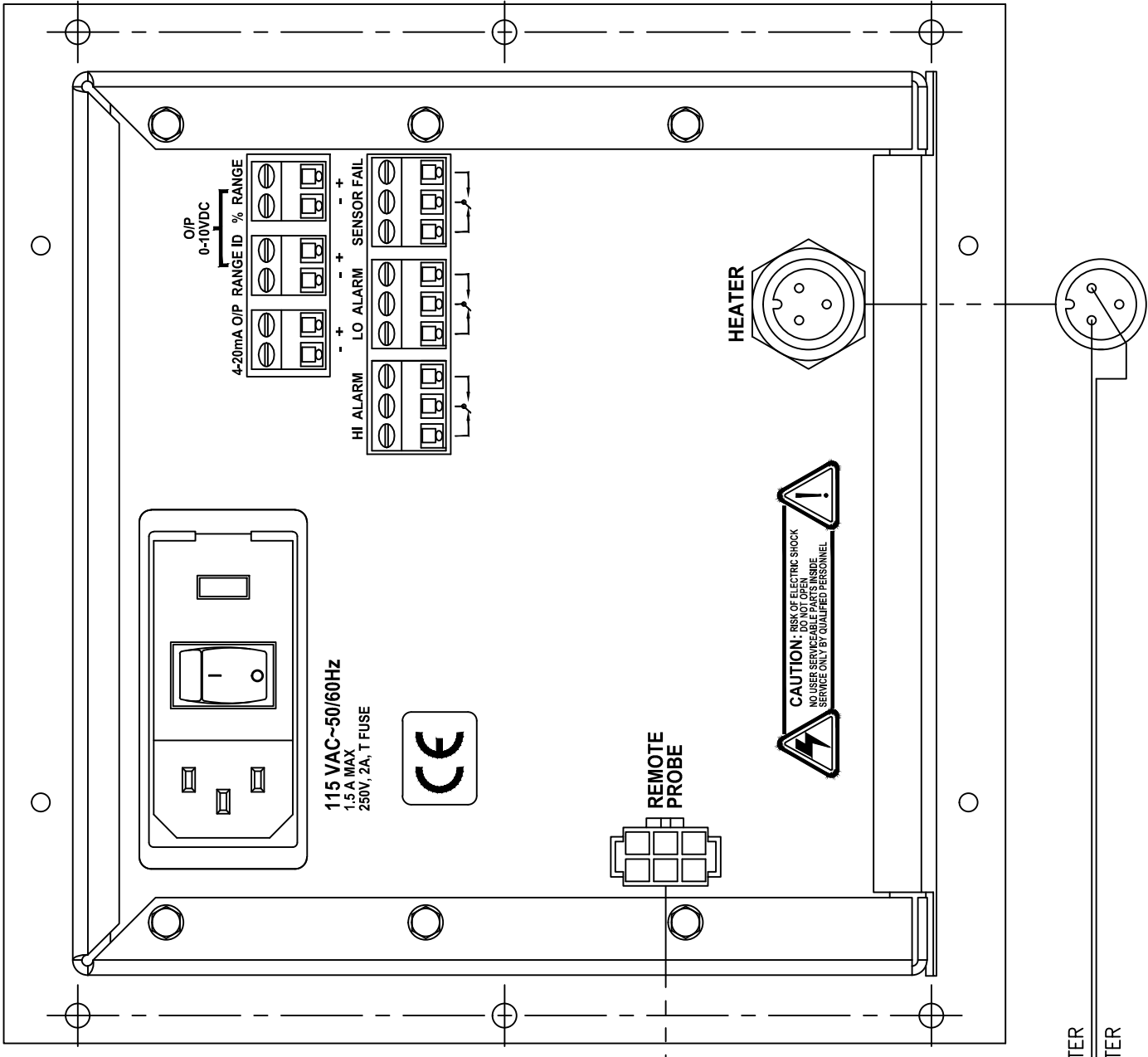

REV	DESCRIPTION	DATE	APP.	REV.
0	INITIAL RELEASE	05/18/05	AA	--
1	MODEL NO WAS Z IS L	07/21/05	JCR	JCR
2	REVISED CABLE WIRNG CONNECTIONS TO TS	8/2/13	RF	VF

UNLESS OTHERWISE SPECIFIED		UNLESS OTHERWISE SPECIFIED	
DIMENSIONS ARE IN INCHES		TOLERANCE	
ANGULAR ±1/2°		LINEAR .XX = ±.02	
		.XXX = ±.010	
S/	SIGNATURES	DATE	TITLE
I/	DRT: JOHN REYES	05/17/05	INTERCONNECTION DIAGRAM
N/	CHK:		CONTROL UNIT TO PROBE
P/	APPR:		MODEL 9060L
O/ D-77712	ENGR: ANGEL ALEGRIA		
F/ D-77713	C.O.: 072591		
REFERENCE	CAD ID C77925-2		
	MATL	NOTED	DWG NO. C-77925
			REV 1 OF 2
			SHEET 1 OF 2
			SCALE NONE
			SIM NONE
			REV 2

THIS DRAWING IS THE PROPERTY OF TELEDYNE ANALYTICAL INSTRUMENTS AND CONTAINS CONFIDENTIAL INFORMATION. IT IS NOT TO BE COPIED, REPRODUCED OR USED WITHOUT WRITTEN PERMISSION.

TELEDYNE
Analytical Instruments
A Business Unit of Teledyne Instruments, Inc.
City of Industry, California 91748, USA

1

2

3

4

D

C

B

A

REVISIONS
SEE SHEET 1

CONTROL UNIT
(REAR VIEW)

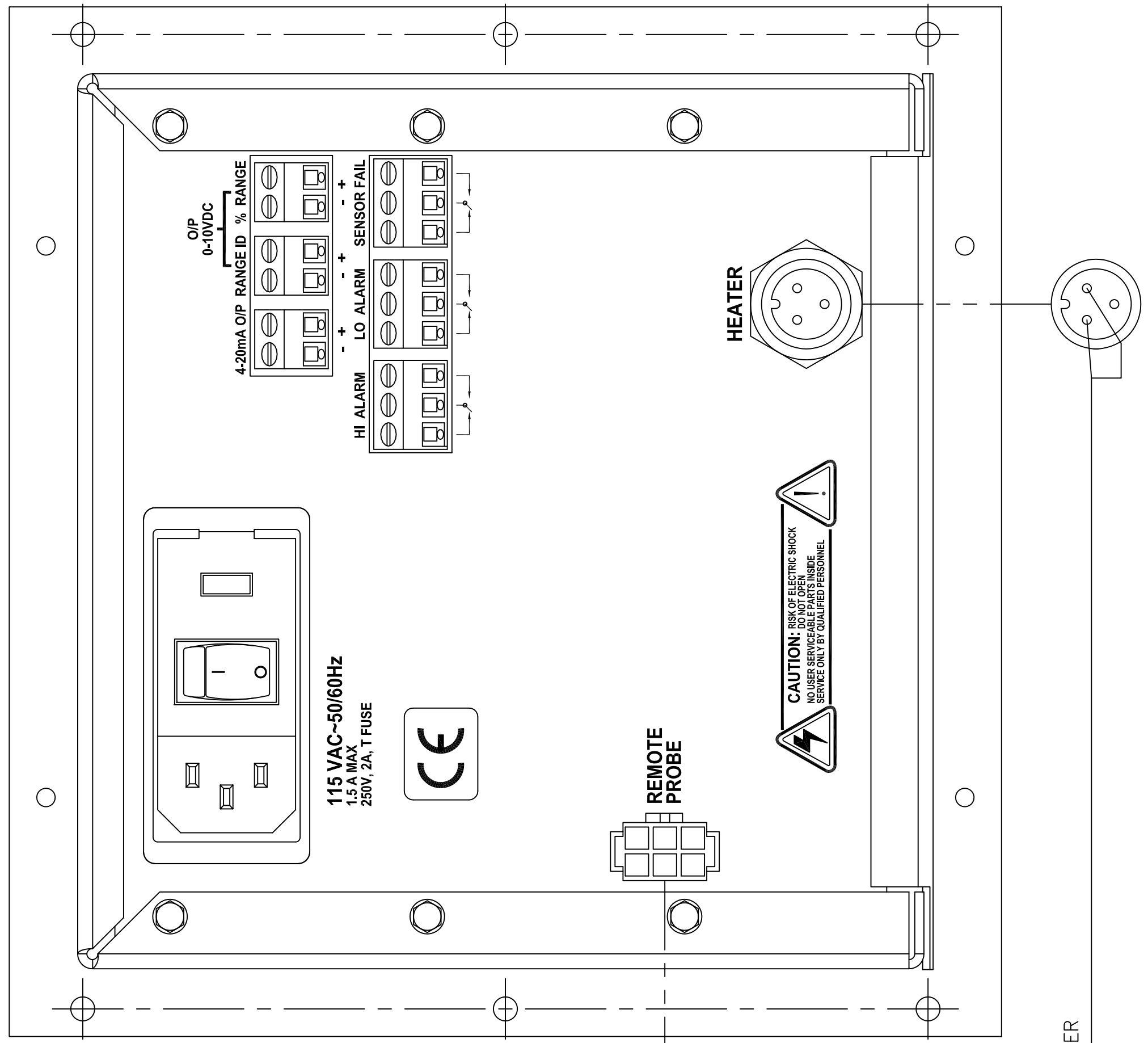

OXYGEN PROBE
(TOP VIEW)

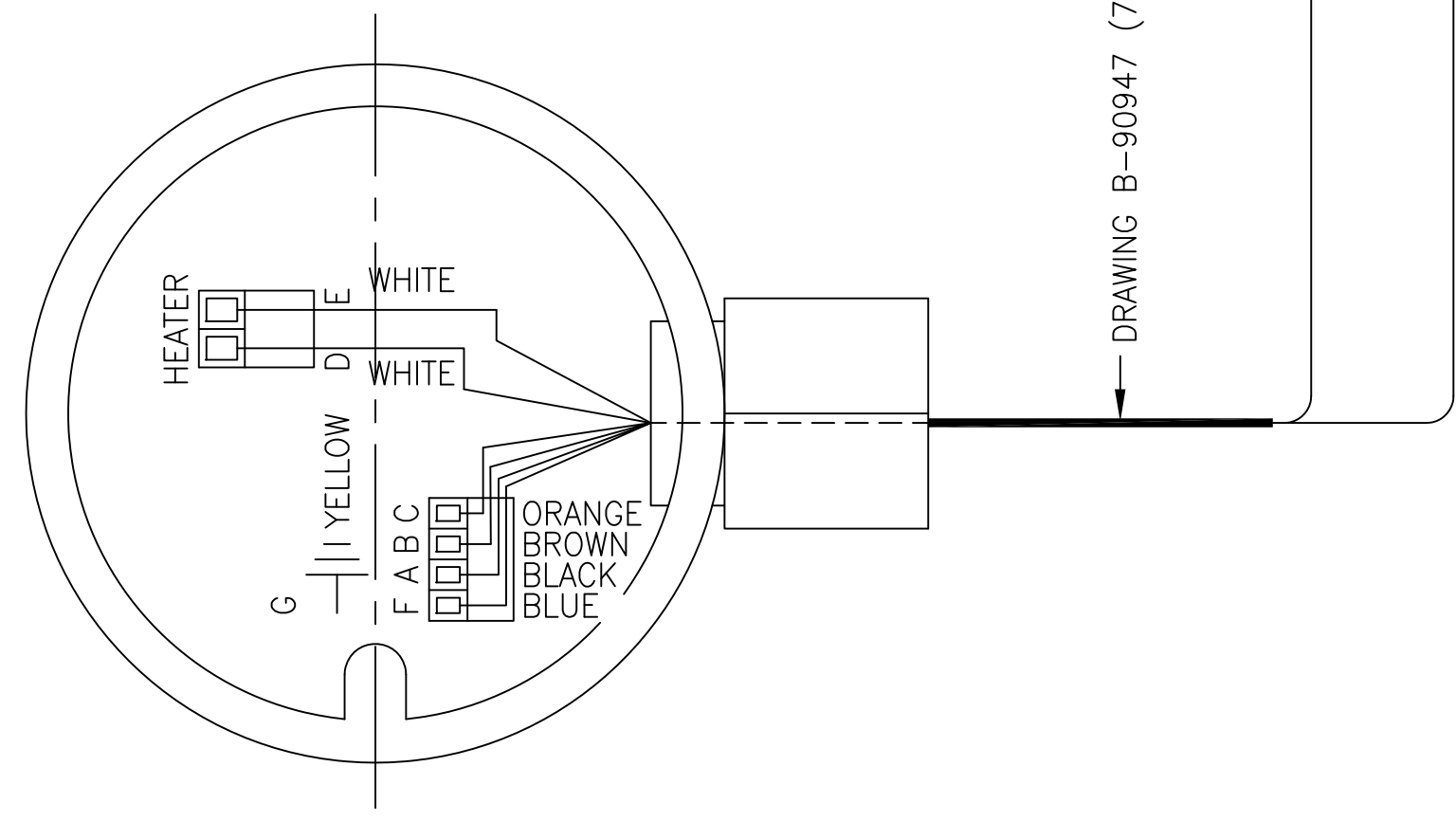

REVISIONS
SEE SHEET 1

SHEET 2 OF 2

DWG NO. C-77925

REV. 2

1

2

3

4

D

C

B

A